

JVC HIGH FIDELITY TURNTABLES

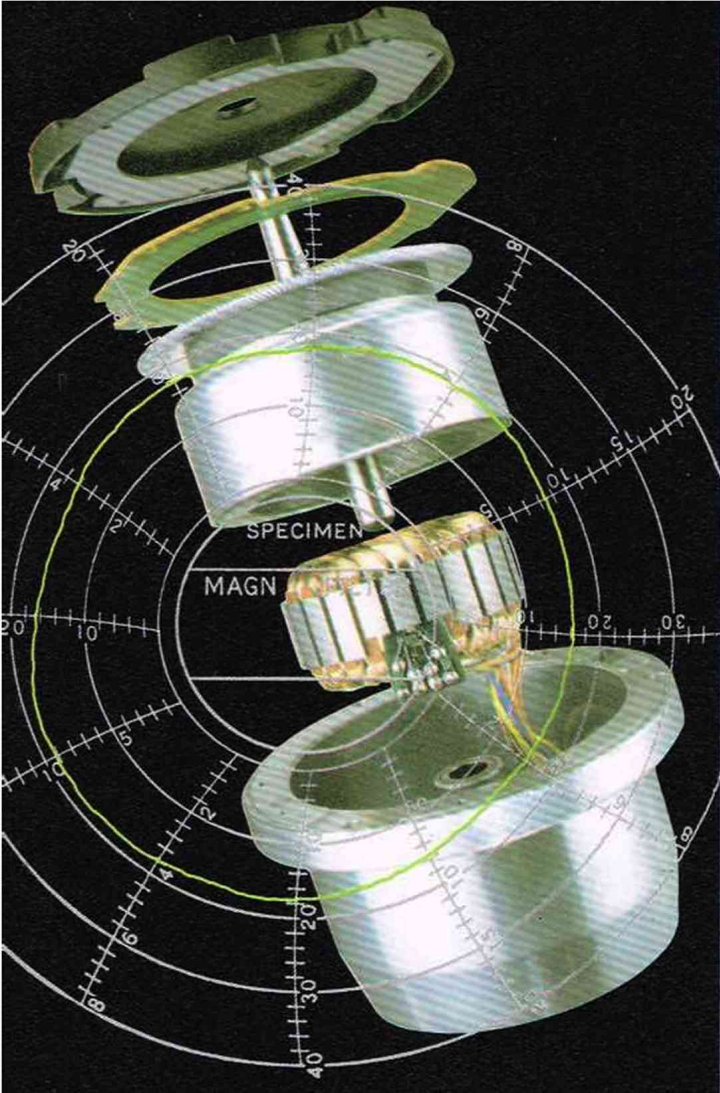

Closer to the Musical Truth

JVC Turntable Technology



Details Do Count

Think of a turntable as a precision instrument for the reproduction of music. Remember that it contains both mechanical and electrical parts. Then consider the JVC ingenuity that goes into every one of our high-fidelity turntables to achieve impressive overall performance every time over long years of use.

We design and make all important parts that require our critical surveillance and control. The fact that we make motor units for ourselves is important, since every turntable we produce is equipped with a motor that is specifically designed for each particular turntable for balanced performance. What's more, we use machine tools, custom-designed for our specific needs; the shafts in our motors boast twice truer roundness of 0.6 micron than other shafts.

This is how we know that every part in every JVC turntable is the very best available. That's also how we know that when they are assembled under our strict quality control procedures in our modern factories, every JVC turntable, regardless of price, lives up to the art of true high-fidelity reproduction. Details do count at JVC, and the performance of each of the turntables in this brochure proves it.

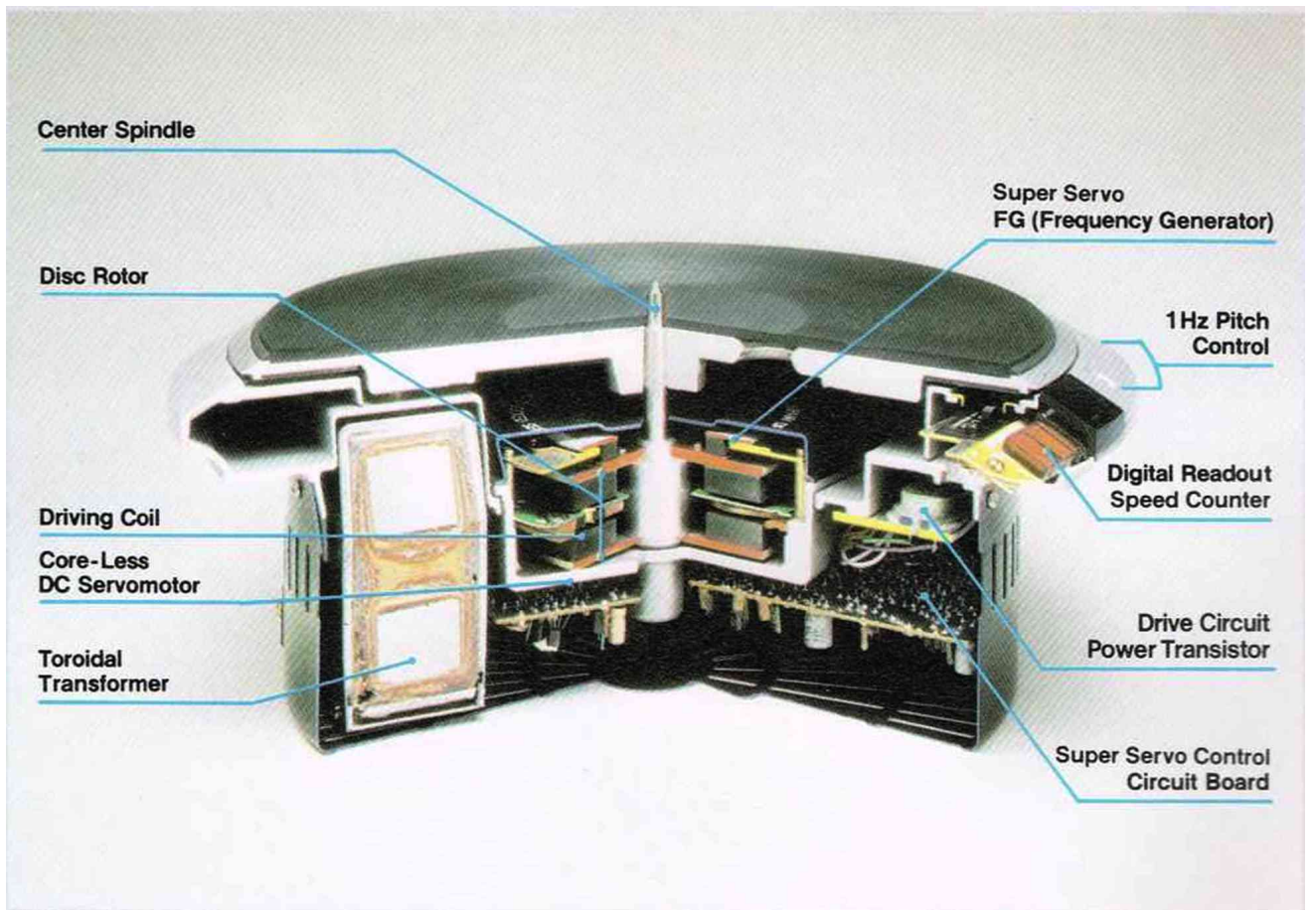

Edison invented the phonograph, but JVC made it Quartz. Quartz turntable technology has become so popular it's time to remind ourselves that JVC started it all in 1974 with the introduction of the world's first Quartz Turntable for consumers. Earlier that year our studio-use Quartz version created a sensation in professional circles. The Age of Quartz had arrived in high fidelity.

Because platter speed accuracy is so severely influenced by variables of temperature, time, and mechanical inaccuracies, the introduction of a way to effectively avoid speed errors was a true technological coup. The JVC Quartz Turntable is that way.

During the past decade, motor design made a rapid evolution from simple induction, synchronous to sophisticated servo systems. At the same time, the

drive mechanism made a similar evolution, starting with simple rim through belt to the now popular direct drive. JVC Quartz, introduced most recently, is a quantum jump over previous turntable technology. It's no wonder that JVC is pleased to announce that the QL-10 through QL-A2 models in this brochure represent the world's first *full* line of Quartz turntables. Here are some of their technical highlights.

JVC Quartz Technology

When a voltage is applied across a thin wafer of quartz crystal, the latter emits a frequency so accurate that it deviates no more than 0.004% per hour. This is why quartz is used as an accurate reference source in precision timepieces and turntables. As illustrated in the block diagram below, every JVC Quartz Turntable has a

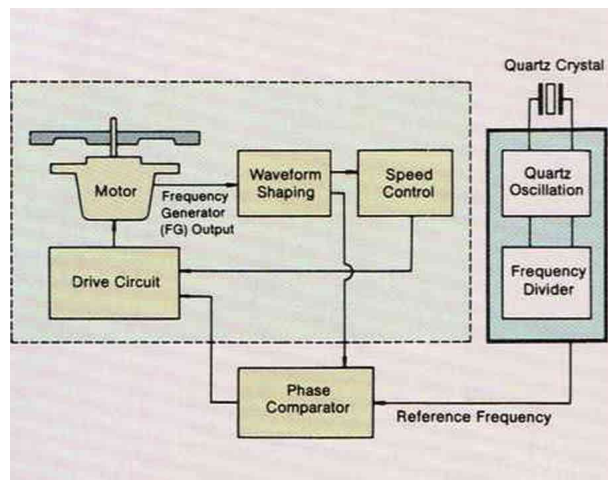

Block Diagram of JVC Quartz Turntable

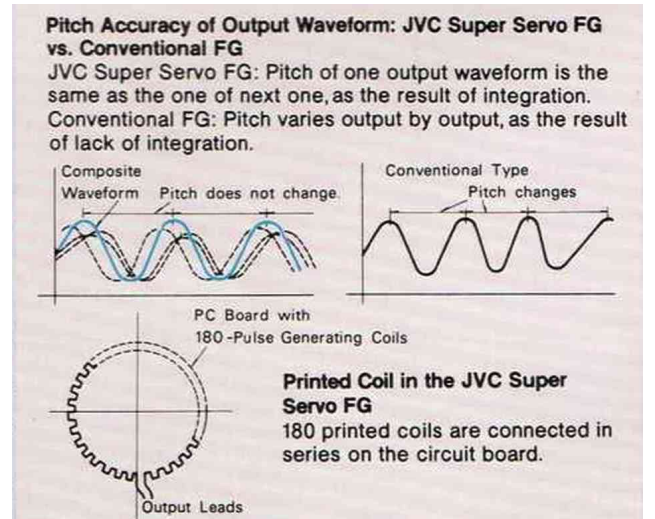

Bring You Closer to the Musical Truth

second "phase" servo system in addition to the conventional speed servo system.

In this second servo system, the Phase Comparator circuit compares the signal from the frequency generator — called JVC Super Servo in JVC Quartz Turntables — built into the motor, with the one from the Quartz oscillator. If this circuit detects frequency (phase) difference between these two signals, then the Phase Control circuit sends corrective information to the motor instantly. It is the combination of a precision Quartz oscillator and JVC Super Servo Frequency Generator that makes for uncanny speed accuracy of JVC Quartz Turntables. Here are the three big advantages of this combination:

1) Speed is at least 100 times more accurate than in conventional direct-drive turntables, which can easily turn too fast or too slow by as much as one full rotation in just half an hour. (0.0001% for Quartz vs. 0.1% for direct drive)

2) Speed is more than 100 times more accurate in the face of voltage or temperature changes than in conventional direct-drive turntables. JVC Quartz Turntables offer accurate platter rotation, impervious to external environments. (0.00003% vs. 0.03%)

3) Load characteristics are more than 100 times better than in conventional direct-drive turntables. Even when the stylus is tracing heavily modulated grooves, platter speed remains rock steady. (0% vs. 0.2%)

JVC Frequency Generator: JVC Super Servo

A servo system requires one form of mechanism or another to detect the moment-to-moment platter speed and to send corrective information to the electronics circuits.

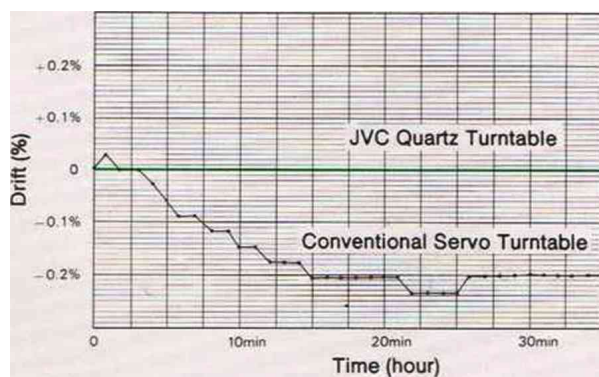

Time Drift

JVC's Super Servo Frequency Generator is one, and it's a remarkable device. It is formed of a magnetic disc with 180 (or 90 with some models) slits on its periphery. The disc is positioned face to face with a round circuit board with 180 (or 90) printed-coil elements. Thus, as the disc rotates together with the motor shaft, 180 (or 90) pulses of 100Hz (or 50Hz) signals — if the selected speed is 33rpm — are generated in the printed coils. The output of the coils is then integrated and averaged. This JVC Super Servo Frequency Generator has the following two advantages.

1) The integration process reduces the chance of detection error to practically zero. With it, one total output waveform from the generator has essentially the same pitch as the next one, because 180 (or 90) pulses are integrated and averaged for one total output instant to instant. With a non-integrated type frequency generator, however, just one output waveform is generated and used as corrective information. Because of inherent mechanical error the motor unit suffers, it may have a different pitch from the next one, which results in speed inaccuracy.

2) Being inaccessible to users, it retains its original, factory-adjusted accuracy over long years of use.

JVC's Belt Drive Turntables

In our new turntable lineup there are two belt-drives, one fully automatic and the other auto-return. In addition to the advantage that the belt drive offers — filtered motor vibrations for a high signal-to-noise ratio — and automatic convenience, our JL-F30 and A20 models feature motors, arms and cabinets, each specifically designed for the other. At JVC we take care not to create imbalanced products, with too much spent on motors and

too little on arms and cabinets. Such a policy would give you direct-drive turntables with insensitive tonearms and howl-prone cabinets - and you wouldn't want us. Instead we aim to offer you a total balance of perfection, priced reasonably, to continually bring you Closer to the Musical Truth.

JVC Tonearm Technology

■ **New Gimbal Support** — This JVC-exclusive device positions and supports the mass of the tonearm at a point where the vertical and horizontal planes interact. Thus in principle, the JVC New Gimbal Support creates a friction-free unipivot support, and is therefore highly sensitive and responsive. But unlike a "true unipivot system," ours can guarantee precision over many years of service because it is far more rugged.

■ **TH (Tracing Hold) Arm** - This is a static balancing system developed by JVC to provide still more tonearm stability and tracing accuracy by lowering the center of gravity of the entire tonearm mass to a point *below* its fulcrum.

■ **Parallel Lifter Point** — Ordinary lifters tend to allow tonearms to more or less "stagger" laterally when the tonearm is raised or lowered. JVC prevents this by letting the lifter point travel along the arm lifter bar in operation.

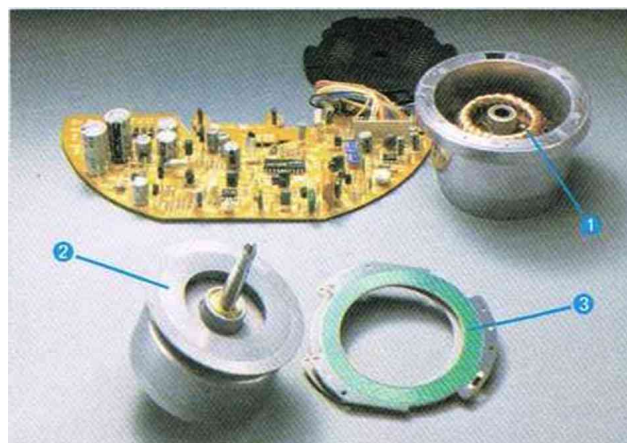

JVC Super Servo Frequency Generator
 Ⓞ 24-Slot Stator Coil Ⓞ Speed Detection Disc Ⓞ Speed Detection FG Coil

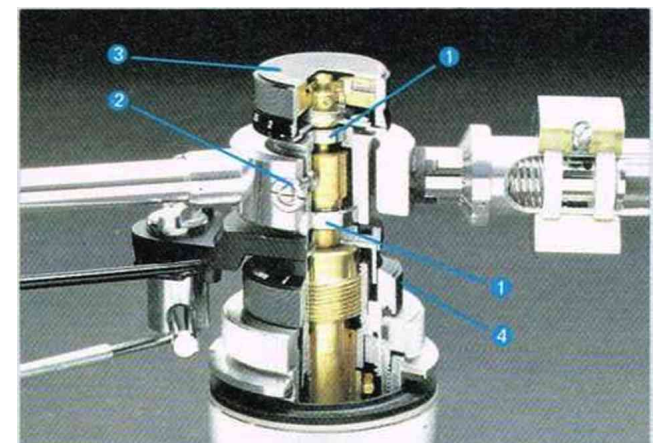

New Gimbal Support Cutaway
 Ⓞ Horizontal Bearing Ⓞ Vertical Bearing Ⓞ Anti-Skating Knob Ⓞ Arm-Height Fine-Adjustment Knob



- Incomparably Low Wow/Flutter (0.02%) Results from JVC Quartz Technology
- Digital Speed Counter
- JVC Super Servo Frequency Generator
- 1 Hz Step Pitch Control ($\pm 6\text{Hz}/440\text{Hz}$)

The QL-10 Quartz Turntable is a distinguished state-of-the-art product and JVC is proud to place it at the top of our wide line. Like the finest precision measuring apparatus, it offers a digital speed counter of unimpeachable reliability. There is a 1Hz step pitch control to answer the needs of professional users and musicians alike, along with precision performance as represented by the 0.02% wow/flutter (WRMS) and other outstanding specifications. Ask your dealer for a thorough demonstration of the best Quartz turntable by the people who made turntables Quartz — the QL-10 from JVC.

JVC Quartz and Pitch Control

Only JVC Quartz technology as offered in the QL-10 (and QL-8) can offer the incontestably unique advantage of Pitch Control in steps of a miniscule 1Hz over a $\pm 6\text{Hz}$ range in reference to the international standard pitch of $a'=440\text{Hz}$.

While other makers offer their quartz turntables with pitch control facility, ours is just about the *only* system to maintain that accuracy by keeping the Quartz servo in operation.

Digital Speed Counter

This JVC Quartz model incorporates 3 4-digit LED counter to indicate the speed of the platter within .01 rpm. The indication accuracy of this built-in precision digital measuring apparatus is entirely dependable.

Quick Stop/Start

The platter of the QL-10 reaches an exact 33-1/3 rpm speed in less than 0.6 seconds after you push the Start button. Stop time is under one second.

Other features of the QL-10 include: New Gimbal Support Tonearm (height-adjustable) in a multi-layered base, oil-damped cueing, an efficient, low-hum toroidal power transformer, electronic switching, "no-cogging" core-less DC motor, and more.



4-Digit Speed Counter



1 Hz Step Pitch Control Buttons

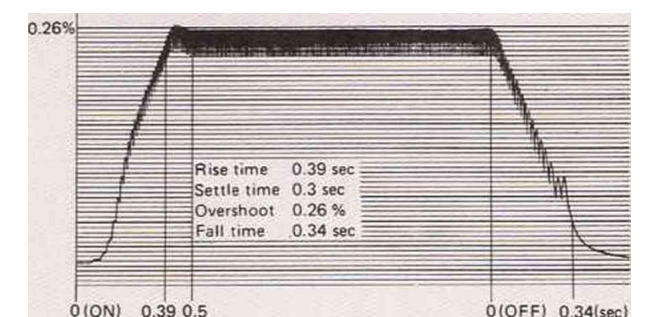

Platter Rise and Fall Response



Not available in Canada.

- **JVC Quartz Technology — Low 0.025% Wow/Flutter**
- **JVC Super Servo Frequency Generator**
- **1Hz Step Pitch Control ($\pm 6\text{Hz}/440\text{Hz}$)**
- **Electronic Quick Stop (Under 1 Sec. Stop)**

But for the absence of the Digital Speed Counter, the QL-8 differs in no other significant way from the top-of-the-line JVC QL-10. Its highly accurate JVC Quartz servosystem, 1Hz Step Pitch Control, JVC Super Servo Frequency Generator and other features provide the assurance of the same high fidelity performance.

JVC Quartz Accuracy

We've used a DC direct-drive servomotor, designed and built under our direct control, inside the JVC QL-8. It features high torque generation and quick acceleration against loads and contributes to the outstandingly low wow/flutter of 0.025% or less over long years of use.

1Hz Step Pitch Control

Using the international standard pitch of $a^1=440\text{Hz}$ as a reference, the QL-8 gives you the ability to change the speed of the platter in such minute amounts as to ef-

fect a change of pitch as small as 1Hz over a $\pm 6\text{Hz}$ range. Unlike other quartz turntables on the market, the JVC QL-8 (and QL-10) includes a servosystem which offers quartz-controlled speed accuracy even as you change pitch.

Positive/Negative Servosystem

Also unlike conventional servos, that in the QL-8 works in both positive and negative directions. Thus the moment the platter is caused, for whatever reason, to spin either too fast or too slow, the fractional discrepancy is instantly corrected to regain absolutely correct speed long before you notice.

No-Howl Design

The cabinet of the QL-8 exhibits a high anti-resonance characteristic to protect the musical nuances on your records. Its heavy weight of 3.3 kg and special multi-layered construction sandwiching special inorganic material prevent harmful low frequencies from reaching the cartridge.

Additional advantages in the QL-8: JVC Super Servo Frequency Generator, Height-Adjustable New Gimbal Support, Quick Stop, One-Row Strobe, Oil-Damped Cueing, and more.

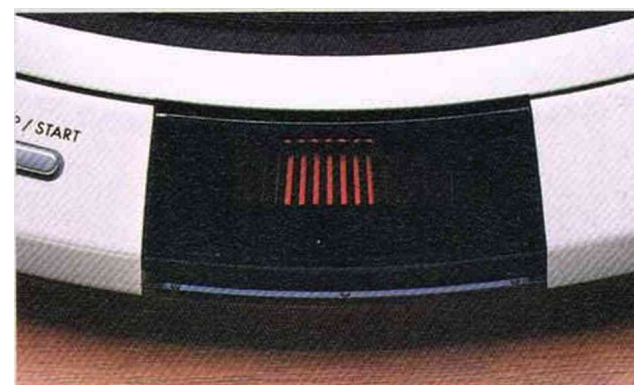

One-Row Strobe



Pitch Control Knob & 1 Hz Step Digital Indicator

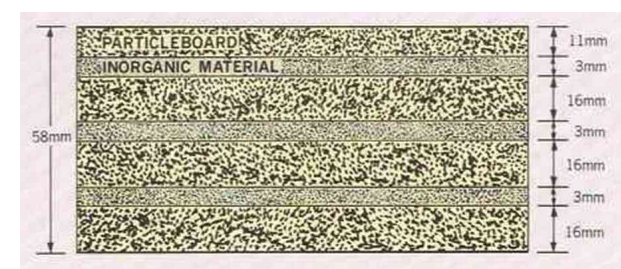

Cross Section of Multi-Layered Cabinet

QL-A7



- JVC Quartz Technology for Low 0.025% Wow/Flutter
- JVC Super Servo Frequency Generator
- Photokinetic End-of-Play Mechanism
- Solid Base

We've used the JVC Quartz Turntable technology to great advantage in the QL-A7, then have added a unique arm operation mechanism to increase operating convenience. This model has our "Photokinetic End-of-Play" device so that when the stylus reaches the lead-out groove on the record, the arm is lifted free without a moment's hesitation, and then the platter is stopped. One advantage is that the JVC design does *not* link the arm with the platter in any mechanical way, thus the high performance standards of each are never threatened. Wow/flutter is less than 0.025% (WRMS), and the signal to noise ratio is better than 73dB (DIN-B). Here are some of the details:

JVC Quartz for the Musical Truth

Accurate platter rotation is maintained in the QL-A7 with the JVC Quartz servomotor that's virtually impervious to influence from the environment. Changes in temperature or humidity, voltage fluctuations and even circuit warm-up changes never bother it. Thermal drift is less than 0.00005%/C° and stability against voltage rises/drops as wide as 10V is complete.

Since the QL-A7 has JVC's DC servomotor, precision Quartz oscillator, no-error JVC Super Servo Frequency Generator and a proven direct-drive mechanism designed and produced by our own engineers and craftsmen, its superb original performance is retained over the years.

Heavy Platter and JVC's DC Servomotor

The best Quartz servosystem in the world deserves only the most precise of motors. Since we were the ones to originate Quartz servo control for turntables, it was only right that we should make a precision DC servomotor to go along with it in the JVC QL-A7. It features powerful torque of more than 1kg-cm and is assisted for smooth rotation characteristics by its built-in JVC Super Servo Frequency Generator. A JVC-exclusive "super-finish" technique ensures mechanical

precision and long-term durability and includes, in part, the amazing 0.6n roundness in the vital motor shaft. The platter of the QL-A7 weighs a heavy 2.2kg (4.8 lbs.) with its thick rubber mat and has a large 350kg-cm² moment of inertia. These figures translate, of course, into superb musical performance by reducing flutter and keeping the speed constant even in the face of suddenly increased loads. Particular care has been taken to ensure that motor-caused resonance never occurs to spoil your music.

JVC's "Photokinetic End-of-Play" Mechanism

Yes, the QL-A7 is a full-fledged *manual* turntable. But it also includes a feature that automatically lifts the tonearm and stops the platter the moment the stylus enters the innermost lead-out groove of your record. Our unique "Photokinetic End-of-Play" device works independently of the platter system; it is formed of a photosensor and a sophisticated mechanism including a plunger for no-contact, error-free operation. Benefits you'll enjoy include reduced tonearm mass for improved arm sensitivity, compared with a conventional tonearm auto mechanism. For convenience there are a Cue Lever and a Record Size Selector Knob up front.

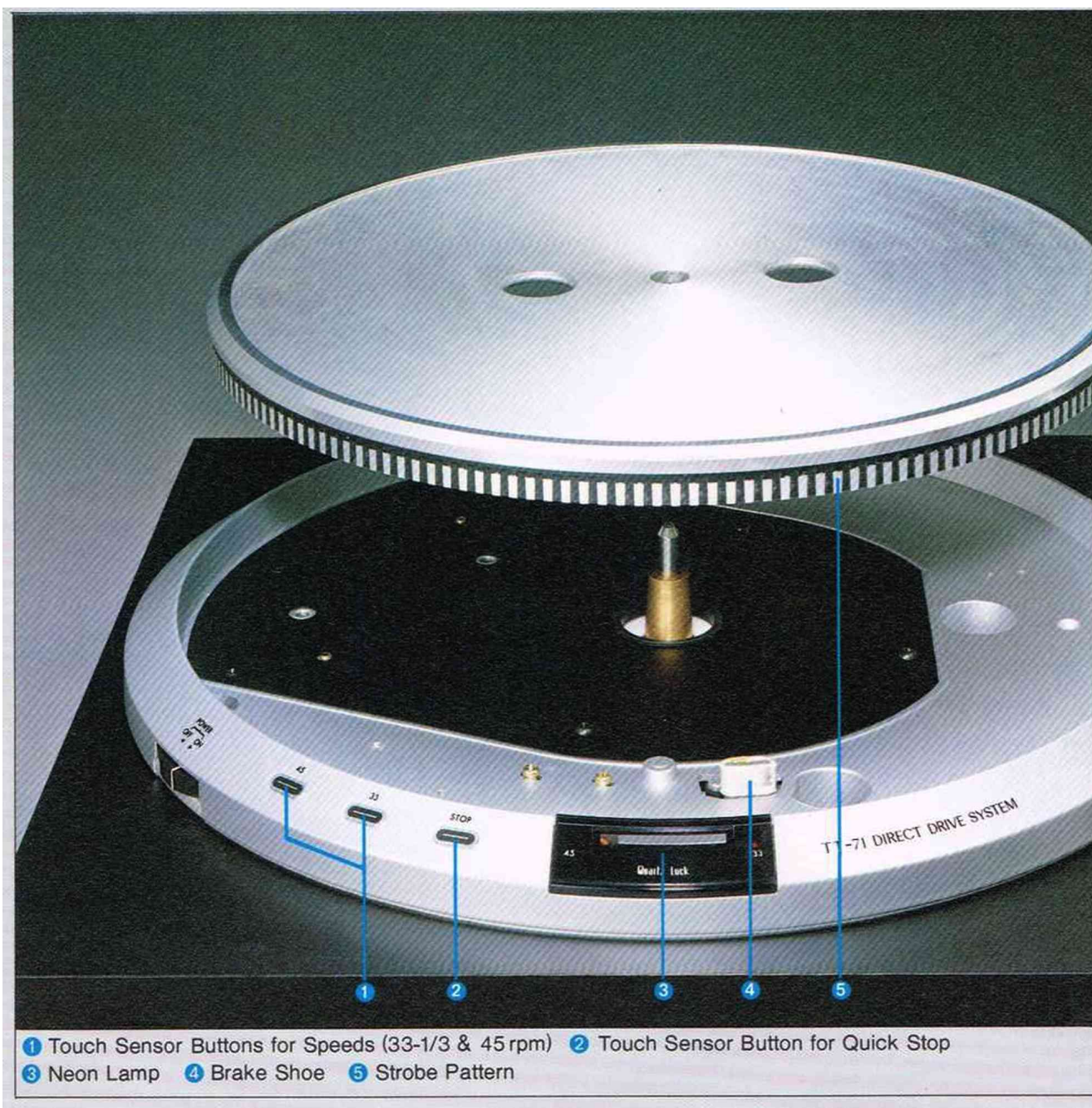

1 Touch Sensor Buttons for Speeds (33-1/3 & 45 rpm) 2 Touch Sensor Button for Quick Stop
3 Neon Lamp 4 Brake Shoe 5 Strobe Pattern

Touch Sensors for Speed Change

Stopping the platter or changing speeds from 33-1/3 to 45 rpm is a breeze. Simply touch the appropriate Touch Sensor button — the lightest of touches will do — and you get immediate results. The built-in mechanical brake with an electromagnetic plunger stops the platter in less than 1.6 seconds with no wobbles, and speed-up changes are so fast you can hardly see them happen.

One-Row Strobe

Only one row? No more are needed, since the neon strobe lamp is synchronized with the built-in Quartz oscillator. Unlike strobes which are synchronized with power-line AC frequency, this system avoids any chance of fluctuation. You select the speed and the one row of strobe dots is all you need to visually confirm its accuracy.

New Gimbal Support

The tonearm support system on the QL-A7 is our New Gimbal Support offering improved sensitivity, much lower mechanical error and higher rigidity than conventional types. Rare on automatic turntables, it includes an Arm Height Adjustor with an adjustment range of from 42.5 to 50mm so that you may use any

cartridge whatever its height, and Oil-Damped Cueing.

Solid Construction to End Howl

Since the motor and tonearm of the QL-A7 are firmly mounted in the solid, "howl-free" cabinet, neither the sonic bombardment coming from your speakers nor the vibrations of footsteps on the floor can reach the stylus to cause musical degradation. One further JVC touch is the suspension system which effectively soaks up all vibrations — vertical and horizontal alike — thanks to a rubber foot design to effectively prevent muddy or boomy bass reproduction. The insulators are height-adjustable to help you keep your JVC Quartz QL-A7 strictly on the level.



One-Row Strobe

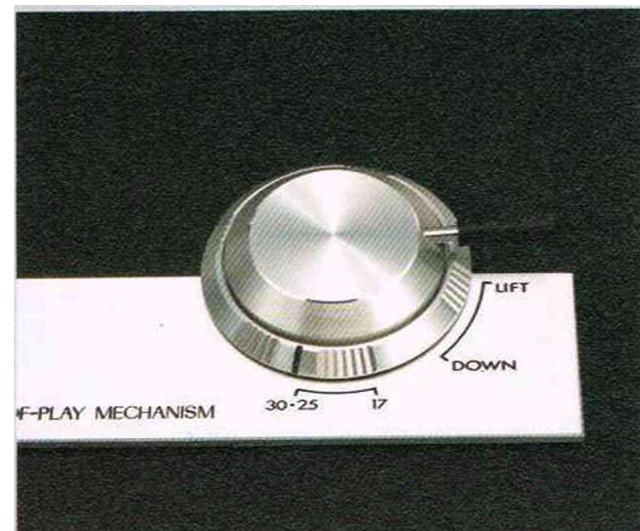

Record Size Selector/Cueing Lever

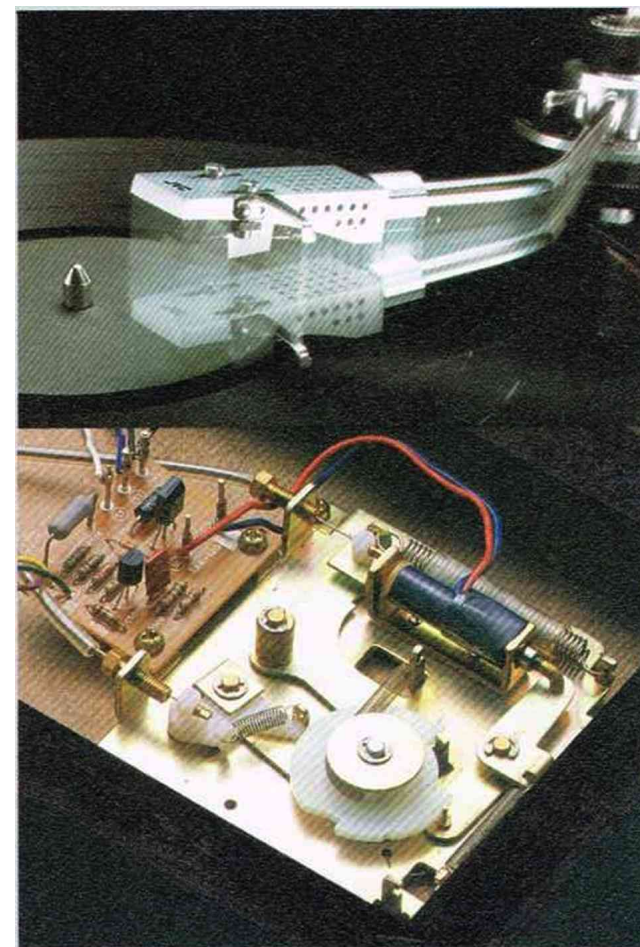

JVC Photokinetic End-of-Play Mechanism

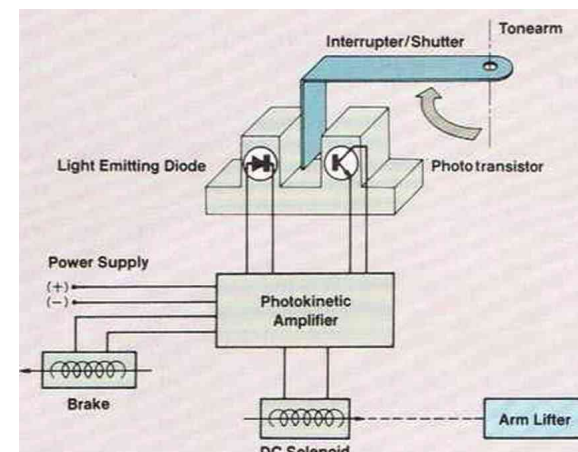

Block Diagram of JVC Photokinetic End-of-Play System

QL-7



- **JVC Quartz Technology — Low 0.025% Wow/Flutter**
- **JVC Super Servo Frequency Generator**
- **Height Adjustable New Gimbal Support**
- **Touch Sensors for Speed Change/Stop**

The QL-7 is nearly identical to the QL-A7, though it lacks the end-of-play arm liftup/stop convenience and is correspondingly less expensive. Specifications are identical, including less than 0.025% (WRMS) wow/flutter, and a signal-to-noise ratio of better than 73dB (DIN-B). Other performance parameters are equally superb, and intentionally superior to those of conventional direct-drive turntables in the same price range.

JVC Quartz and JVC Motor

JVC Quartz Technology is pleasantly apparent in the QL-7, achieving the most uncanny speed accuracy. This accuracy is in no way compromised by our use of a DC direct-drive motor that spins the heavy 2.2 kg (4.8 lbs.) platter (including rubber mat) with powerful torque (over 1 kg-cm). Exceptionally low wow and flutter of 0.025% (WRMS) and speed drift of no more than 0.0001%/hour are other pro-

minent features you can count on to bring you Closer to the Musical Truth.

Quick Start and Quick Stop

The QL-7A, like every JVC Quartz Turntable in this brochure, has a quick start feature; in no more than 1.4 seconds after you turn on the turntable, the platter rotates precisely at 33 rpm or 45 rpm. It also has a quick stop feature using a low-wear mechanical brake, which stops the platter in less than 1.6 second. For ease of operation, three buttons — one each for 33 rpm, 45 rpm speeds and Stop — use Touch Sensors: a simple brush of one with your finger selects speed or stops the platter.

Quartz-Synchronized Strobe

Since the strobe is illuminated by the neon lamp whose pulses are synchronized by the Quartz servo, just one row of strobe dots is required. The pattern is sharply contrasted and always clear.

Other features of the QL-7 include: New Gimbal Support, Parallel Isolator Suspension, Oil-Damped Cueing, solid cabinet, and more.

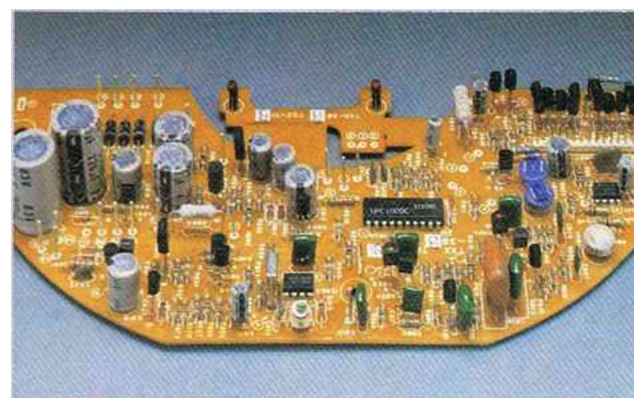

JVC Super Servo Circuit Board



Touch Sensor Buttons for Speeds & Quick Stop

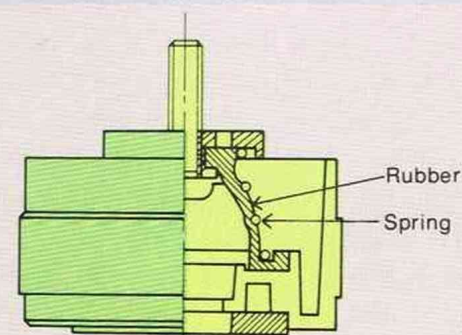

Parallel Isolator Suspension

JVC QUARTZ TURNTABLE

QL-5



- JVC Quartz Technology
- JVC Super Servo Frequency Generator
- Highly Sensitive New Gimbal Support
- Quick Start and Quick Stop

The QL-5 has all that's needed for your musical enjoyment, including, of course, JVC Quartz servo. It's the "no-frills" model in our lineup of Quartz Turntables, and its balanced electrical and mechanical construction makes it a particularly good buy.

JVC Technical Knowhow

To produce expensive state-of-the-art equipment is not our only virtue; our knowhow, accumulated during a half century of work, permits us to use the best of electronics and machining technique to offer reasonably priced equipment for serious audiophiles. JVC Quartz Turntables are no exception. In the medium-priced QL-5, for instance, we've designed a special C-MOS 1C which incorporates all necessary circuits for the servo system. This configuration not only simplifies the circuit-board layout but improves overall dependability.

JVC Quartz and Super Servo Frequency Generator

With its simplified circuitry and mechanisms, none of the JVC Quartz Technology has been omitted from the QL-5. The precision Quartz oscillator, responsive servo system, JVC Super Servo Frequency Generator, accurate direct drive DC servo motor, etc., are all part of this attractive and supremely reliable turntable package. All superb basic parameters are all included.

Heavyweight Platter

To absorb all miniscule vibrations, the platter must be heavy and accurately concentric. The dynamically balanced one used on the QL-5 is heavy, weighing 2kg (4.4 lbs.), rubber mat included. Wow and flutter is thus virtually eliminated, while speed accuracy is maintained against suddenly increased loads. Among other QL-5 features are the Quick Stop, New Gimbal Support, newly-designed One-Row Strobe, Oil-Damped Cueing, solid cabinet, and JVC height-adjustable Dome Isolating Suspension.



Power On/Off & Speed Switches



Parallel Lifter Point & Anti-Skating Knob



QL-50: This is the QL-5 model without tonearm; you can couple our precision Quartz Turntable system with a precision tonearm of your choice.

QL-F4



- JVC Quartz Technology — Low 0.025% Wow/Flutter
- JVC's Core-Less Direct-Drive Motor
- Fully Automatic Operation — Lead-In/Repeat/Return/Shut-Off
- JVC Super Servo Frequency Generator

The best of both turntable worlds - platter rotational accuracy and full automatic operational ease — are included in the QL-F4. The combined use of our core-less motor, plus the direct-drive mechanism and our renowned JVC Quartz Technology, is the secret behind the performance of the QL-F4, and its low wow/flutter of 0.025% (WRMS). We believe you won't find another Quartz turntable in this price range on the market that offers so much full automatic convenience as does the QL-F4.

JVC Quartz for Accuracy

The QL-F4 features the JVC Quartz servosystem which incorporates a precision Quartz oscillator, JVC Super Servo Frequency Generator and responsive servo circuit. Its major highlight is the JVC core-less direct-drive motor; this doesn't "cog" and thus assures abso-

lutely smooth and accurate revolution, and leads to low wow/flutter of 0.025% (WRMS). This, plus the use of simplified circuits for greater dependability, works together to give you JVC's Musical Truth.

Fully Automatic Mechanism

The QL-F4 offers the convenience of fully automatic operation. Among its unusually versatile functions ■ are: (1) Auto Repeat, offering from 1 to 6 plays at the twist of a rotary control, with the "R" setting offering infinite replays; (2) Auto Lead-In, which raises the tonearm, moves it over the edge of the record, and gently lowers it to the lead-in groove to start playing; (3) Auto - Return, which sets the tonearm automatically to its rest when a play is completed, then shuts the power off. As a bonus, the moment you move the tonearm manually, the QL-F4 can be operated as if originally designed for manual operation.

New Gimbal Support and More

Included in the QL-F4 are: New Gimbal Support, One-Row Strobe, Oil-Damped Cueing, the knob-type Anti-Skate control, low-resonance cabinet, etc.

Dual Magnet Cartridge.

Refer to information for the JL-A20.

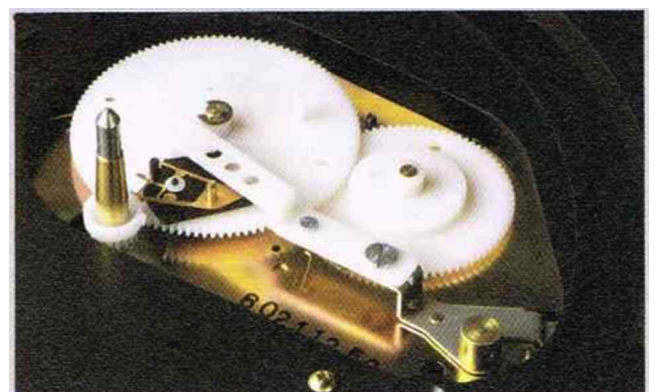

JVC's Auto Mechanism

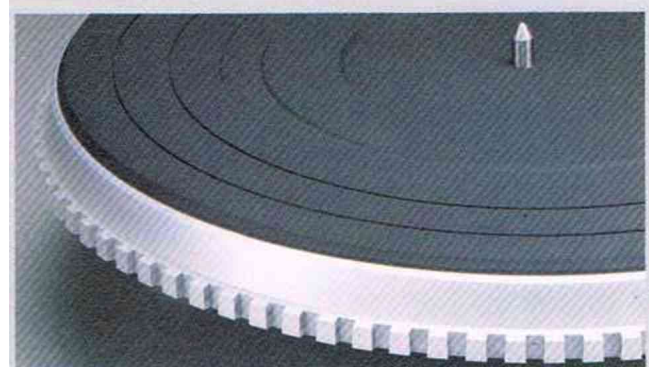

Precision-Finished Aluminum Die-Cast Platter with Strobe Pattern



Operation Panel

QL-A2



- **JVC Quartz Technology —Low 0.025% Wow & Flutter**
- **Dependable JVC Super Servo Frequency Generator**
- **JVC Core-Less Direct-Drive Motor**
- **Auto-Return Convenience at Attractive Price**

The QL-2 delivers the same accuracy and dependability of all JVC Quartz units. In addition to its first-rate specifications of 0.025% wow/flutter (WRMS) and 72dB signal-to-noise ratio (DIN-B), it has an auto-return mechanism for added convenience. Remember, only JVC's advanced techniques can bring such low-priced perfection to your stereo performance.

JVC Quartz Technology

The basic circuit configuration of the QL-A2 is the same as the one used in the QL-F4. An accurate Quartz oscillator, JVC's Super Servo Frequency Generator and "no-cogging" Core-Less DC Servomotor are all included in the QL-A2. Moreover, JVC's simplified circuits and advanced production techniques are abundantly used in its production, leading to dramatically improved stability and accuracy.

New One-Row Strobe

With the One-Row Strobe used with the QL-A2, you can visually confirm speed accuracy. Since the LED (Light Emitting Diode) flashes on and off, synchronized with the frequency of the Quartz, the strobe pattern is always sharp and clean. And since the frequency is changed with the speed, only one row of calibration dots is necessary for communicating the information for both 45 and 33-1/3rpm.

Dependable Auto-Return/Shut-Off

As you move the tonearm toward the record, the platter starts to rotate in our "Quick Play Function." When the lead-out groove of the record is played, the arm automatically lifts itself up, returns to its rest and shuts the power off in the "Auto-Return/Shut-Off Function." Like the QL-F4, the QL-A2 can be operated as if originally designed for manual operation, since its arm may be moved manually anytime. Other features include a Reject Lever that returns the arm during play and a Cue Lever to lift the arm up and down.

The tonearm features the Angular Contact Bearing, Oil-Damped Cueing, insulated arm/weight interface, and more.

Dual Magnet Cartridge.

Refer to information for the JL-A20.



One-Row Strobe



Motor Components of QL-A2



Cueing Lever Up Front

FULLY AUTOMATIC BELT-DRIVE TURNTABLE



- Fully Automatic Lead-In/Repeat/Return/Shut-Off
- Four-Pole Synchronous Motor
- Proven Belt-Drive System
- New Gimbal Support

Cost and performance. The relationship between these two factors has always been a headache to designers/engineers. At JVC, our engineers tried to create - and did - a balanced turntable in the JL-F30 for any serious audiophile, using our own 4-pole synchronous motor and the proven belt-drive system. It's no surprise that it has a low wow/flutter of less than 0.06% (WRMS) and a high signal-to-noise ratio of better than 67dB (DIN-B). With its fully automatic convenience, the JL-F30 offers more performance for less investment than other automatic on the market.

Fully Automatic Operation

As in the QL-F4, the automatic operation in the JL-F30 includes the following three useful conveniences: (1) Auto Repeat — from 1 to 6 repeats, or an infinite number of replays, (2) Auto Lead-In and (3) Auto - Return/Shut-Off. The Start /Reject control is provided to interrupt play and return the arm to its rest.

Manual Operation at All Times

The JL-F30's fully automatic mechanism allows manual operation at any time during play. An oil-damped arm up/down lever ("Cue") is provided, so that you can cue on any of the selections on a record, regardless of arranged sequences.

Belt-Drive Motor

The 4-pole synchronous motor spins the aluminum platter through the linkage of a belt-drive system. Vibration is filtered out and speeds are kept steady against power voltage fluctuations or load changes. JVC quality control is evident throughout this unit. The unit also offers the benefits of a low-silhouette design, making it perfect for any home decor, solid cabinet construction, Parallel Isolating Suspension and other features.

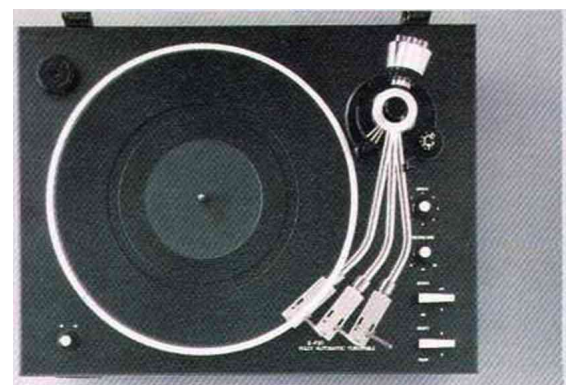

Fully Automatic Arm Operation



Repeat Button



JL-F30's 4-Pole Synchronous Motor

AUTO-RETURN BELT-DRIVE TURNTABLE

JL-A20



- Dependable Auto-Return/Shut-Off Operation
- No-Rumble Belt-Drive
- JVC 4-Pole Synchronous Motor
- Practical Performance at a Pleasing Price

This dependable auto-return belt-drive turntable offers the multiple benefits of precision and convenience. Its uncomplicated mechanism permits the stylus to track freely, as on any first-class manual, until the stylus enters the lead-out grooves of the record, or until you trigger the Reject control. All controls are grouped at the right side to enhance ease of operation.

Auto-Return/Shut-Off Convenience
Place the stylus on the first groove of your favorite record, then sit back and enjoy the music - leaving the rest to the automatic mechanism of this unit which sends the arm to its rest and turns off the power at the end of a record. You operate the Reject Lever to interrupt play and send the arm back to rest. And the oil-damped Cue Lever lets you manually place the stylus on the groove of all your favorite selections, regardless of the arranged sequences of the record.

Dependable, Belt-Drive System

A 4-pole synchronous motor and belt drive system are employed in this unit for silent and reliable operation. The nonferrous die-cast platter of the JL-A20 is spun precisely for more critical operation. This motor maintains very close tolerance speed accuracy regardless of changes in loads or power voltages: Wow and flutter is less than 0.06% (WRMS) and the signal to noise ratio is better than 63dB (DIN-B).

TH and Anti-Skate Device

The tonearm features JVC's TH (Tracing Hold) system to avoid mistracking, distortion, channel imbalance and undue record wear. The anti-skate device is of the easy-to-use knob type that lets you apply the required anti-skate force even while the arm is tracking a record. Record and stylus wear is thus reduced. Like the JL-F30, this model features the low-silhouette look and gets you closer than you've ever been to The Musical Truth.

Dual Magnet Cartridge.

The MD-1029 Dual Magnet Cartridge included in this turntable assures you lasting high performance. It features a smooth 10 to 25,000 Hz frequency response, with channel separation of better than 25dB (1kHz). The tracking force is 1.5 to 2.5 grams.



JVC Belt-Drive Mechanism

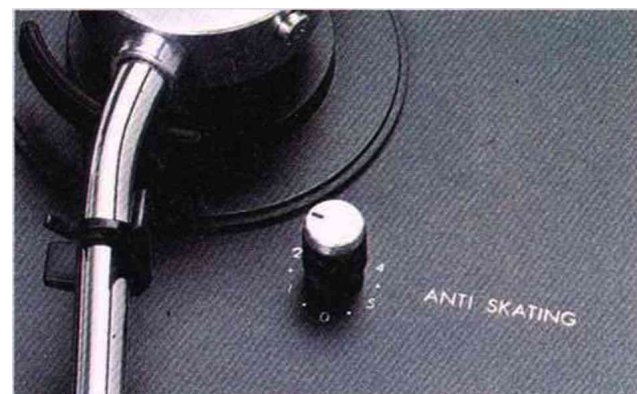

Anti-Skating Knob

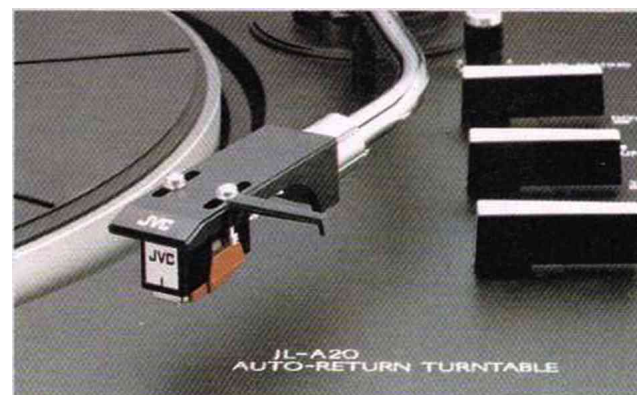

JVC's MM Cartridge, MD-1029

	QL-10	QL-8	QL-A7	QL-7	QL-5
MOTOR:					
Type--	Core-less DC servomotor	DC servomotor	DC servomotor	DC servomotor	DC servomotor
Drive System:	Direct-drive system	Direct-drive system	Direct-drive system	Direct-drive system	Direct-drive system
Speeds:	33-1/3 and 45rpm	33-1/3 and 45rpm	33-1/3 and 45rpm	33-1/3 and 45rpm	33-1/3 and 45rpm
Speed Detection System:	Integrated frequency generator	Integrated frequency generator	Integrated frequency generator	Integrated frequency generator	Integrated frequency generator
Servosystem:	Quartz servosystem	Quartz servosystem	Quartz servosystem	Quartz servosystem	Quartz servosystem
Pitch Control Range:	±6Hz (Standard: 440Hz)	-6Hz (Standard: 440Hz)	—	—	—
Speed Change:	Electronic switching	Electric switching	Touch sensor	Touch sensor	Electric switching
Start-up Time:	<0.6 sec. (60°)	<1 sec. (120°)	<1.4 sec. (180°)	<1.4 sec. (180°)	<1.4 sec. (180°)
Wow and Flutter:	<0.02% (WRMS) <0.04% (DIN)	<0.025% (WRMS) <0.045% (DIN)	<0.025% (WRMS) <0.045% (DIN)	<0.025% (WRMS) <0.045% (DIN)	<0.025% (WRMS) <0.045% (DIN)
Signal-to-Noise Ratio:	>65dB (IEC-B) >75dB (DIN-B)	>63dB (IEC-B) >73dB (DIN-B)	>63dB (IEC-B) >73dB (DIN-B)	>63dB (IEC-B) >73dB (DIN-B)	>63dB (IEC-B) >73dB (DIN-B)
Start-up Torque:	>1.8kg cm	>1.3kgcm	>1kg cm	>1kg cm	>800 grams cm
Speed Deviation:	<0.002%	<0.002%	<0.002%	<0.002%	<0.004%
Load Characteristics:	0% (under 120-gram loads)	0% (under 100-gram loads)	0% (under 120-gram loads)	0% (under 120-gram loads)	0% (under 100-gram loads)
Drift (hour):	0.00004%/H	0.00004%/H	0.0001%/H	0.0001%/H	0.0001%/H
Voltage Drift (2:10V):	15%	0%	0%	0%	0%
Thermal Drift (°C):	0.00003%/X	0.00003%/rC	0.00005%/°C	0.00005%/C	0.00005%/rc
Quick-Stop Time:	<1 sec.	<1 sec.	<1.6 sec.	<1.6 sec.	<1.6 sec.
PLATTER:					
	316mm aluminum die-cast	316mm aluminum die-cast	313mm aluminum die-cast	313mm aluminum die-cast	312mm aluminum die-cast
TONARM:					
Type:	Statically-balanced arm with New Gimbal Support on TH (Tracing Hold) System	Statically-balanced arm with New Gimbal Support on TH (Tracing Hold) System	Statically-balanced arm with New Gimbal Support on TH (Tracing Hold) System	Statically-balanced arm with New Gimbal Support on TH (Tracing Hold) System	Statically-balanced arm with New Gimbal Support on TH (Tracing Hold) System
Effective Length:	245mm	245mm	245mm	245mm	245mm
Tracking Error:	+1°48' -nr	+ r-48 . -1°31'	--V48- . -1°3r-----	+ 1°48 . - 1=31'	+ 1°48' —1°31'
Overhang:	15mm	15mm	15mm	15mm	15mm
Applicable Tracking Force:	0 — 3 grams (0.1-gram steps)	0 — 3 grams (0.1-gram steps)	0 — 3 grams (0.25-gram steps)	0 — 3 grams (0.25-gram steps)	0 — 3 grams (0.25-gram steps)
Applicable Cartridge Weight: (including headshell weight)	12— 32 grams	12 — 32 grams	14.5 — 23.5 grams	14.5 — 23.5 grams	14.5 — 22 grams (shell weight: 10 grams)
Arm Elevation Range:	40 — 60mm	40 — 60mm	42.5 — 50mm	43.5 - 54.5mm-----	39 — 51mm
Operation Mode:	Manual	Manual	Auto liftup/stop	Manual	Manual
CARTRIDGE SUPPLIED:					
GENERAL:					
Dimensions (H x W x D):	197 x 510 x 410 (mm) 7-3/4 x 20-5/64 x 16-9/64 (inches)	197 x 510 x 410 (mm) 7-3/4 x 20-5/64 x 16-9/64 (inches)	165 x 481 x 403 (mm) 6-1/2 x 18-15/16 x 15-7/8 (inches)	162 x 477 x 401 (mm) 6-3/8 x 18-3 4 x 15-3/4 (inches)	165 x 481 x 403 (mm) 6-1/2 x 18-15/16 x 15-7/8 (inches)
Weight:	19.5kg (42.9 lbs.)	18.5kg (40.7 lbs.)	12kg (26.4 lbs.)	10.8kg (23.8lbs.)	10.5ikg (23.1 lbs.)

QL-10

Signal-to-Noise Ratio (IEC-B)

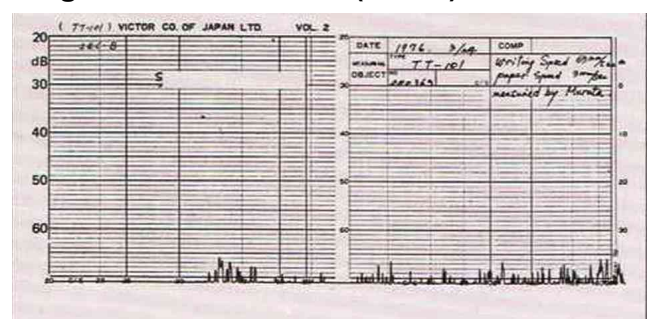

QL-8

Signal-to-Noise Ratio (IEC-B)

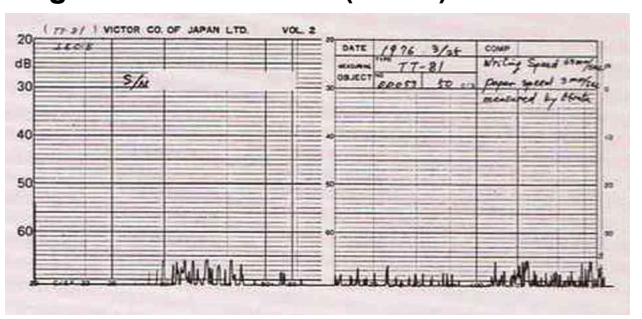

QL-A7/QL-7

Signal-to-Noise Ratio (IEC-B)

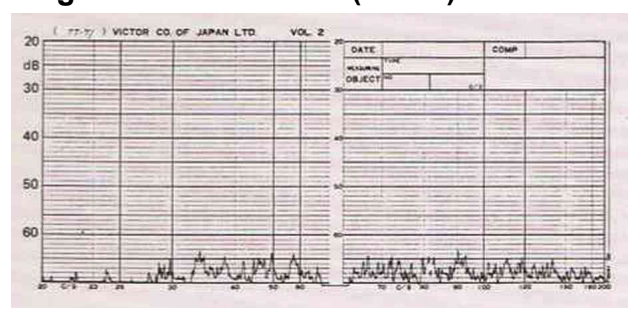

Time Drift

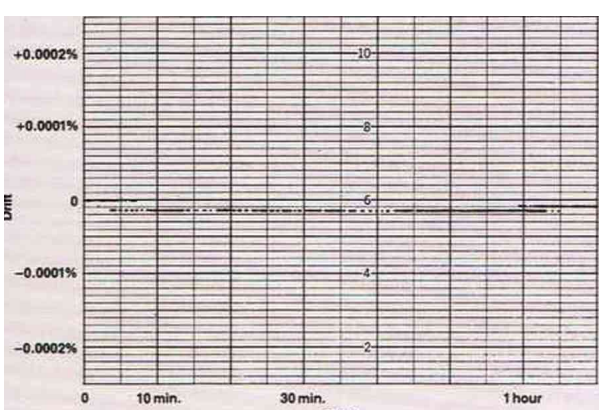

Time Drift

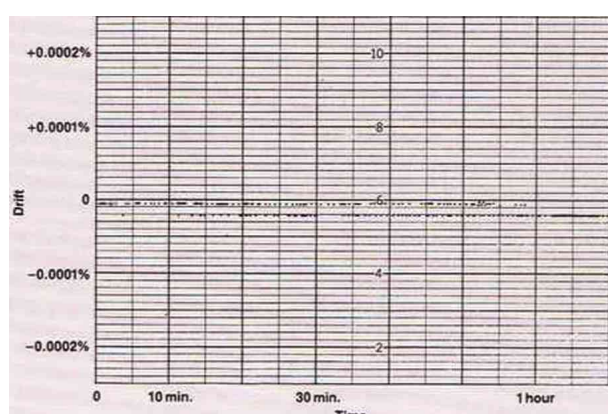

Time Drift

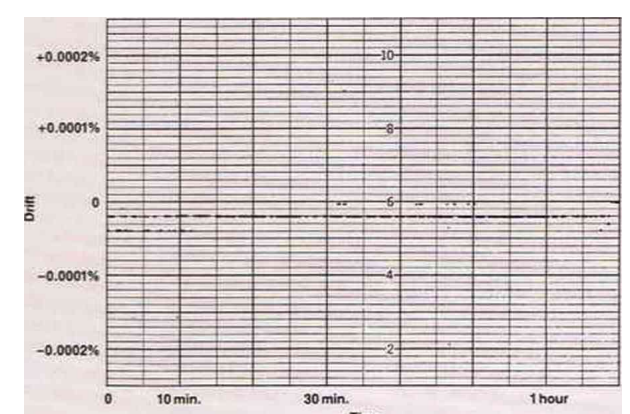

Wow/Flutter (WRMS)

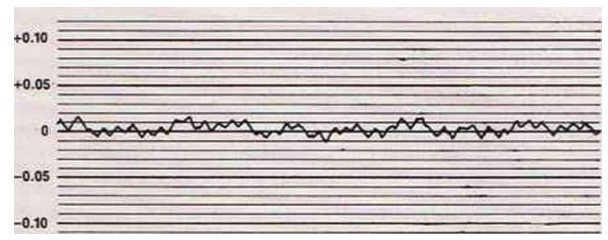

Wow/Flutter (WRMS)

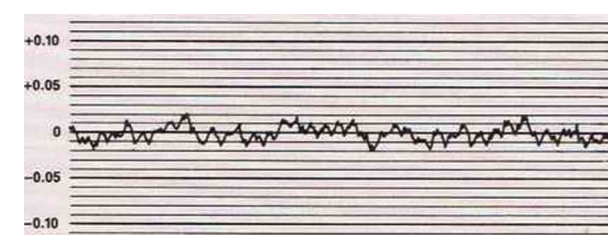

Wow/Flutter (WRMS)

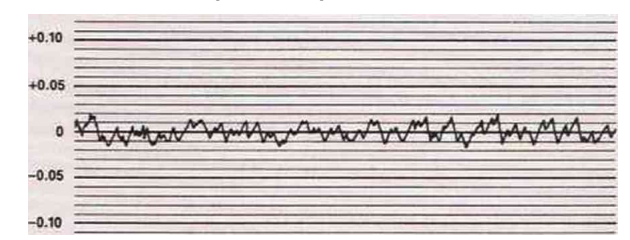

	QL-F4	QL-A2
MOTOR:		
Type:	Core-less DC servomotor	Core-less DC servomotor
Drive System:	Direct-drive system	Direct-drive system
Speeds:	33-1/3 and 45rpm	33-1/3 and 45rpm
Speed Detection System:	Integrated frequency generator	Integrated frequency generator
Servosystem:	Quartz servosystem	Quartz servosystem
Pitch Control Range:	—	—
Speed Change:	Electric switching	Electric switching
Start-up Time:	14 sec. (180)	1.4 sec. (180)
Wow and Flutter:	0.025% (WRMS) < 0.045% (DIN)	0.025% (WRMS) 0.045% (DIN)
Signal-to-Noise Ratio:	-62dB (IEC-B) >72dB (DIN-B)	+62dB (IEC-B) -72dB (DIN-B)
Start-up Torque:	650 grams cm	-650 grams cm
Speed Deviation:	< 0.004%	< 0.004%
Load Characteristics:	0% (under 100-gram loads)	0% (under 100-gram loads)
Drift (hour):	0.0001 %/H	0.0001 %/H
Voltage Drift (-10V):	0%	0%
Thermal Drift (C):	0.00005%/°C	0.00005%/ C
Quick-Stop Time:	—	—
PLATTER:	312mm aluminum die-cast	312mm aluminum die-cast
TONEARM:		
Type:	Statically-balanced arm with New Gimbal Support on TH (Tracing Hold) System	Statically-balanced arm on TH (Tracing Hold) System
Effective Length:	220mm	220mm
Tracking Error:	+3 35' -0 43	-3 35' -0 43
Overhang:	15mm	15mm
Applicable Tracking Force:	0 — 3 grams	0 — 3 grams
Applicable Cartridge Weight (including headshell weight):	14.5 — 22 grams	14.5 — 22 grams
Arm Elevation Range:	—	—
Operation Mode:	Fully automatic	Auto return
CARTRIDGE SUPPLIED:	MD-1029	MD-1029
GENERAL:		
Dimensions (H x W x D):	147 x 460 x 365 (mm) 5-3/4 x 18-1/8 x 14-3/8 (inches)	147 x 460 x 365 (mm) 5-3/4 x 18-1/8 x 14-3/8 (inches)
Weight:	7.3kg (16 lbs.)	6.5kg (14.3 lbs.)

	JL-F30	JL-A20
MOTOR:		
Type:	4-pole synchronous	4-pole synchronous
Drive System:	Belt-drive system	Belt-drive system
Speeds:	33-1/3 and 45rpm	33-1/3 and 45rpm
Speed Change:	Mechanical	Mechanical
Wow and Flutter:	0.06% (WRMS) 0.08% (DIN)	<0.06% (WRMS) <0.08% (DIN)
Signal-to-Noise Ratio:	-57dB (IEC-B) +67dB (DIN-B)	>53dB (IEC-B) >63dB (DIN-B)
PLATTER:	309mm aluminum die-cast	300mm aluminum die-cast
TONEARM:		
Type:	Statically-balanced arm with New Gimbal Support on TH (Tracing Hold) System	Statically-balanced arm on TH (Tracing Hold) System
Effective Length:	220mm	220mm
Tracking Error:	-3 35' -0 43	+ 3'35' -0'43'
Overhang:	15mm	15mm
Applicable Tracking Force:	0 — 3 grams	0 — 3 grams
Applicable Cartridge Weight (including headshell weight):	14.5 — 22.5 grams	13 — 21 grams
Operation Mode:	Fully automatic	Auto return
CARTRIDGE SUPPLIED:		MD-1029
GENERAL:		
Dimensions (H x W x D):	130 x 460 x 368 (mm) 5-1/8 x 18-1/8 x 14-1/2 (inches)	130 x 460 x 368 (mm) 5-1/8 x 18-1/8 x 14-1/2 (inches)
Weight:	7.0kg (15.4 lbs.)	6.0kg (13.2 lbs.)

CARTRIDGE MD-1029: SPECIFICATION

CARTRIDGE:	
Type:	Dual Magnet (MD-1029)
Stylus:	0.6 mil. Diamond for DT-35
Optimum Tracking Force:	1.5 to 2.5 grams
Output Voltage:	2.5 mV (1kHz, 5cm/sec)
Frequency Response:	10 to 25,000 Hz
Separation:	Better than 25 dB (1kHz)
Load Resistance:	47 to 100 Kohms
Compliance:	22 x 10 ⁶ cm/dyne (Static) 7 x 10 ⁶ cm/dyne (Dynamic)

Design and specifications subject to change without notice.

QL-5

Signal-to-Noise Ratio (IEC-B)

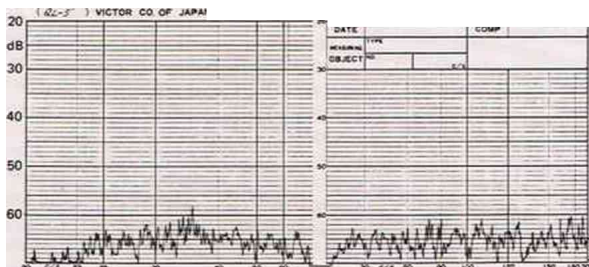

Time Drift

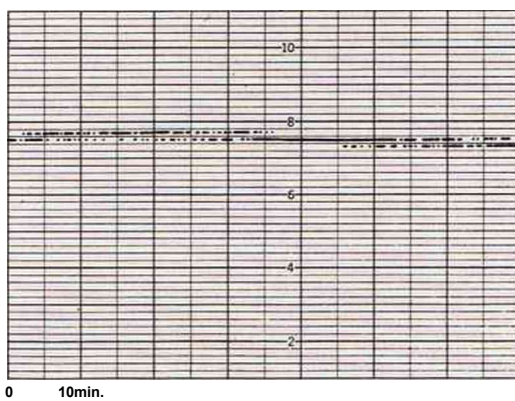

Wow/Flutter (WRMS)

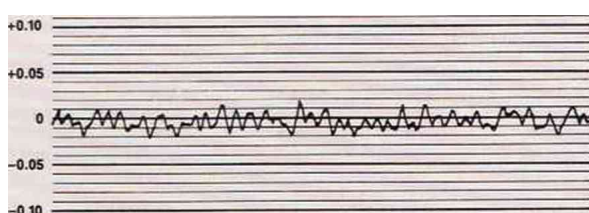

QL-F4

Signal-to-Noise Ratio (IEC-B)

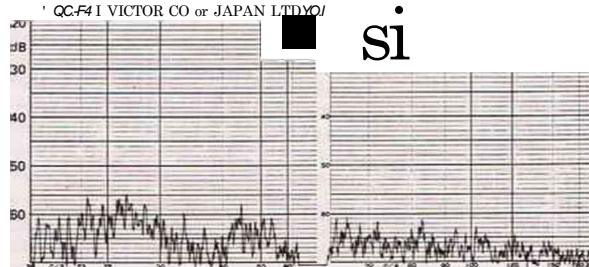

Time Drift

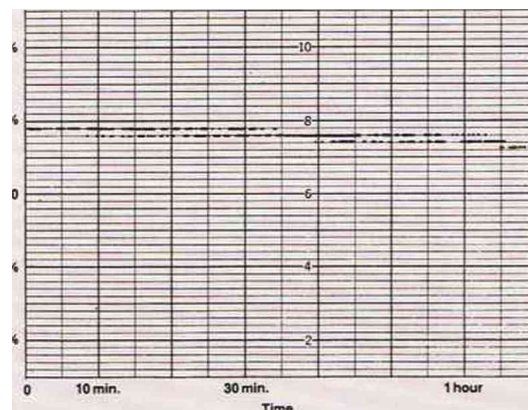

Wow/Flutter (WRMS)

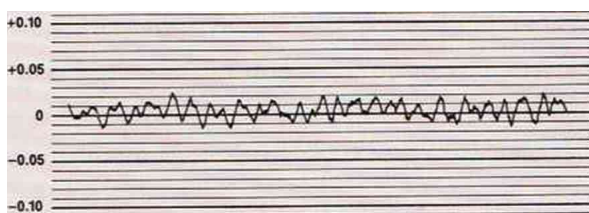

QL-A2

Signal-to-Noise Ratio (IEC-B)

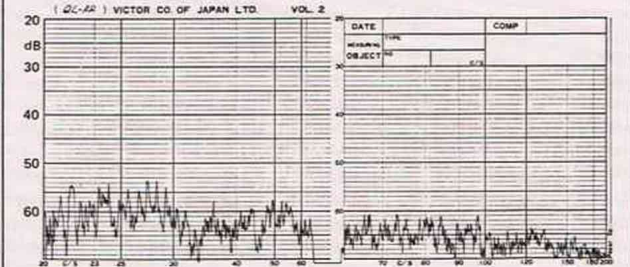

Time Drift

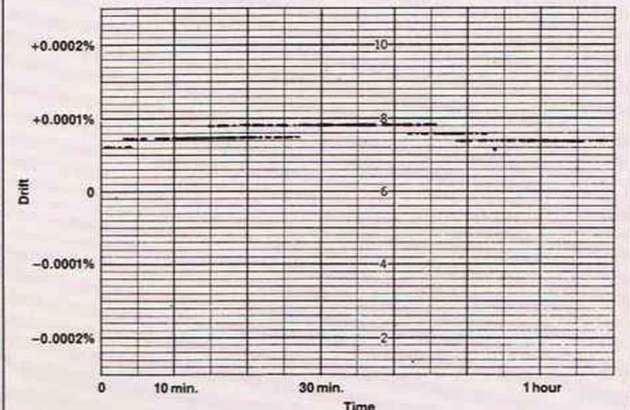

Wow/Flutter (WRMS)

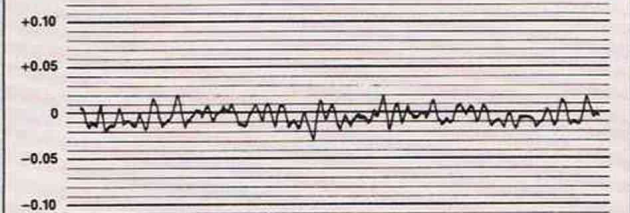

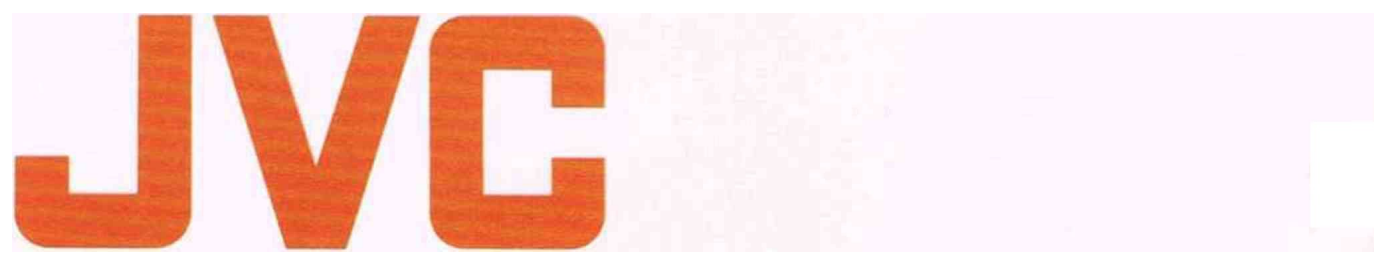

JVC ELECTRONICS OF CANADA. LIMITED

31 Progress Avenue, Unit 14
Scarborough, Ontario M1P 4S6
CANADA

Loud and Proud

HIFIGOTEBORG.se a

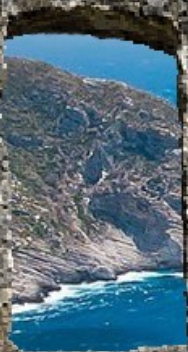

WANT TO RELAX TO BEAUTIFUL
MUSIC

WELCOME

WE HAVE GOOD HIFI AT YOUR
SERVICE

PLEASE WAIT HERE & A MEMBER
OF OUR TEAM WILL BE WITH
YOU SHORTLY.

Or press finger HERE