

# LOCAL CONTROL SYSTEM

600.00

Master Control Link Handbook



THIS MANUAL IS DESIGNED AS  
AN AID FOR AUTHORIZED CUSTOM  
INSTALLERS

**NOTE:** BUILDING AND ELECTRICAL CODES VARY  
FROM LOCALITY TO LOCALITY. MAKE SURE  
THAT THE INSTALLATION IS IN COMPLIANCE  
WITH APPLICABLE CODES. BANG & OLUFSEN  
SHALL NOT BE BE LEGALLY RESPONSIBLE FOR  
INJURY OR DAMAGE CAUSED BY IMPROPER  
INSTALLATION.

## PREFACE

This handbook deals with Bang & Olufsen's Local Control System and AV system, paying special attention to the installation requirements applying to them. Consequently, this handbook is especially addressed to dealers and installers.

Any product, for example a stereo system, a PC, a natural gas system, etc., that has to be incorporated into a network needs to have certain requirements satisfied by the surroundings in connection with its installation. These requirements must ensure the optimal operation of the system after installation.

The same applies to Bang & Olufsen's Local Control System and AV system. Although the requirements are not many, it is essential that they be known since compliance with the basic requirements often determines whether or not the system is able to operate once the installation has been completed.

This handbook gives a brief and precise introduction to the basic rules for the product programme in 92/93 and for future programmes. The rules must be observed in connection with the installation of a Local Control System and/or an AV system.

The handbook has been designed partially as a reference book but the **entire** handbook should be read in order to obtain the total overview. Only then will it serve its purpose as a reference book.

## CONTENTS

- 2 READING INSTRUCTIONS  
How should I read the handbook?
- 3 GENERAL DESCRIPTION OF LOCAL CONTROL SYSTEM AND AV SYSTEM  
What is a Local Control System/AV system, and what can they do for me?
- 4 TECHNICAL DESCRIPTION  
Description of various cables which are typically used in AV & Local Control Systems
- 6 PRODUCT DESCRIPTION  
Description of X-tra kit
- 9 SETUPS  
Description of recommended Local Control System/AV system setups, special setups and option programming
- 13 SETUPS WITH LIGHT CONTROL  
Description of how Light Control can be included in the recommended setups
- 14 DIMENSIONING OF LOCAL CONTROL SYSTEM/AV SYSTEM  
Description of how many X-tra kits and how much cable may be used
- 16 INSTALLATION TYPES  
Description of various installation types
- 18 INSTALLATION TIPS  
Practical advice for use in connection with installation
- 21 TROUBLE SHOOTING GUIDE  
What could be wrong when the system will not operate
- 27 GLOSSARY  
Description of specific words and abbreviations
- 29 ACCESSORIES LIST

## READING INSTRUCTIONS

The hardware (plugs, cables, X-tra kits, etc.) used for connecting Bang & Olufsen's products into a system is always the same, no matter if it is a Beocenter 9500 and an MX 5500 that have to be connected or if it is a Beomaster 7000 and an MX 5500, for example.

The handbook employs various symbols to illustrate audio products, video products and speakers. Unless otherwise stated in the text, these symbols merely have to be understood as covering one of these product areas and **not** as the specific product which the illustration may depict.

Since the handbook is focusing particularly on the basic rules in connection with the installation of the systems, variables which are specific to particular products have been omitted to the greatest possible extent. This means that the handbook will always be relevant in connection with installation of Local Control Systems and AV systems; both with regard to products launched prior to the publication of the handbook and products that will be launched later.

The basic rules applying to the AV and Local Control Systems will always be the same.

**If information specific to a particular product is required, please see Bang & Olufsen's Product Configuration Guide.**

**GENERAL DESCRIPTION**

**What is an AV system?**

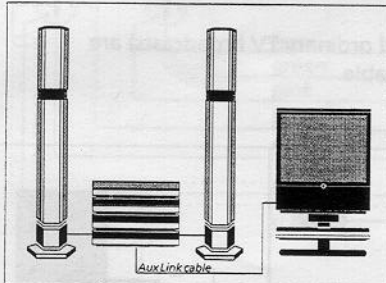

When a Bang & Olufsen audio system and video system are interconnected, they make up an AV system.

An AV system offers a number of possibilities which are not accessible if the products are placed as independent products. For example, in an AV system the sound can be moved from the TV to the audio system speakers; a function that proves its excellence when the sound and the picture have to merge into a higher synthesis. The sound from the audio system can similarly be moved to the TV speakers. This function comes in handy if you wish to record sound from the audio system on the video tape recorder, for example.

The interconnection of the audio and video systems is furthermore a condition for distributing and operating video sources (antenna, cable, decoders and video tape) to and from other rooms in the house.

**What is a Local Control System?**

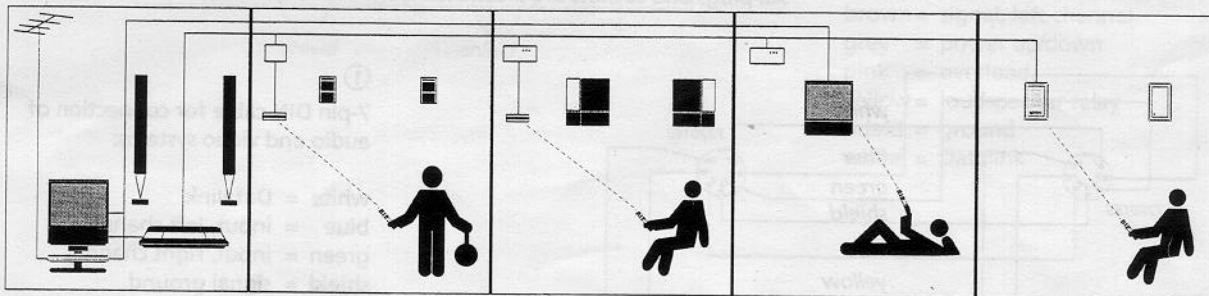

Local Control System is a common denominator for those elements which enable the distribution of sound and picture to different rooms in the house. In other words, the Local Control System enables operation and enjoyment of a centrally placed audio/video system from different rooms in the house. Some of the basic elements included therein are:  
The obligatory 7-conductor MCL cable and X-tra kits (transceivers, MCL 2A relay boxes and MCL 2AV panels).

So, with a centrally placed audio system and a Local Control System it is possible to listen to and operate e.g. a radio, CD player, tape recorder, etc. from other rooms.

If the centrally placed audio system is connected with a video system, thereby forming an AV system, a host of new possibilities are made available. This further allows the distribution of video sources to other rooms. In addition to listening to and operating the audio system from different rooms, it is also possible to watch, listen to and operate the video system from other rooms. For example, you can listen to the TV news through the speakers in the kitchen; or you can watch and operate cable TV and the video tape recorder via the TV in the bedroom. Encoded cable TV programmes can also be watched in the local room, provided that a decoder is connected in the central room. Another possibility is to listen to the radio via the TV in the bedroom, for example.



## TECHNICAL DESCRIPTION

The following section contains a brief description of the cabling typically used in connection with an AV and Local Control System installation.

Pictures (cable, video tape recorder and ordinary TV broadcasts) are distributed through a 75 ohm coaxial cable.

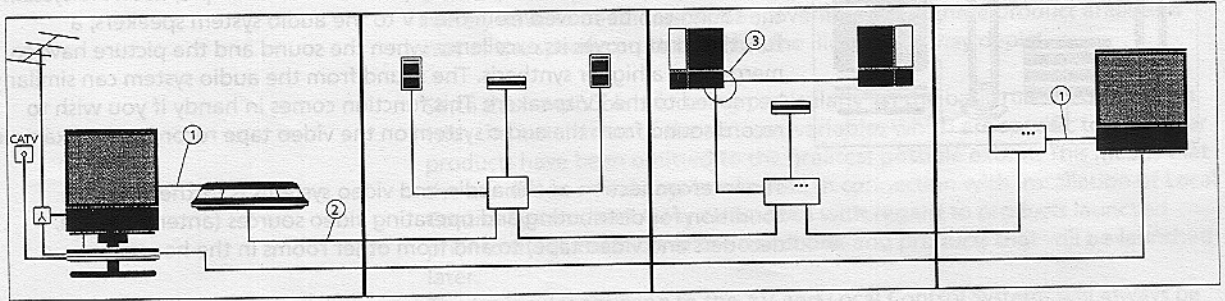

All plugs and sockets are illustrated from the solder side.

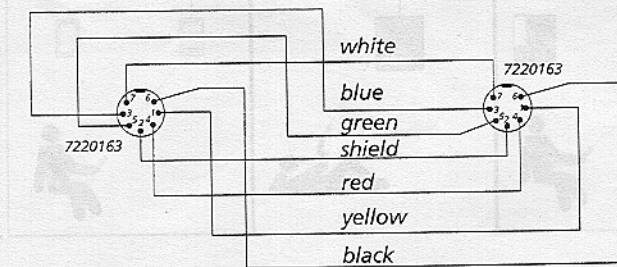

①  
7-pin DIN cable for connection of audio and video systems:

white = Datalink  
blue = input, left channel  
green = input, right channel  
shield = signal ground  
red = output, right channel  
yellow = output, left channel  
black = data ground

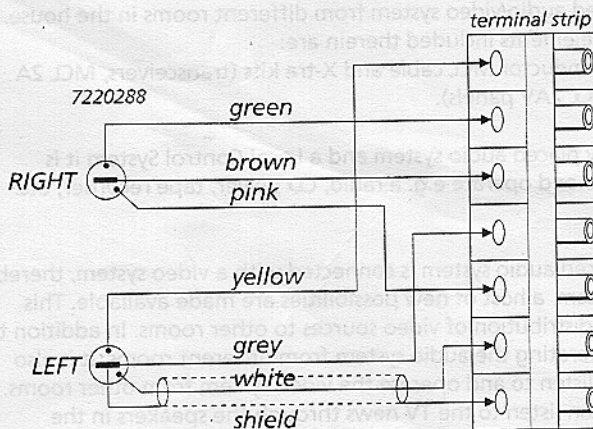

②  
MCL cable between audio system and 7-pin terminal strip:

green = signal, right channel  
brown = ground, right channel  
pink = DC supply  
yellow = signal, left channel  
grey = ground, left channel  
white = Datalink  
shield = data shield

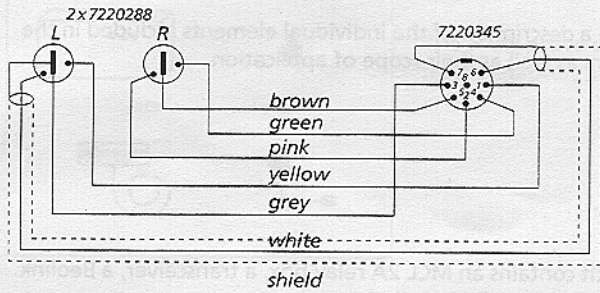

② MCL cable between audio system and 8-pin wall socket:

- brown = ground, right channel
- green = signal, right channel
- pink = DC supply
- yellow = signal, left channel
- grey = ground, left channel
- white = Datalink
- shield = data shield

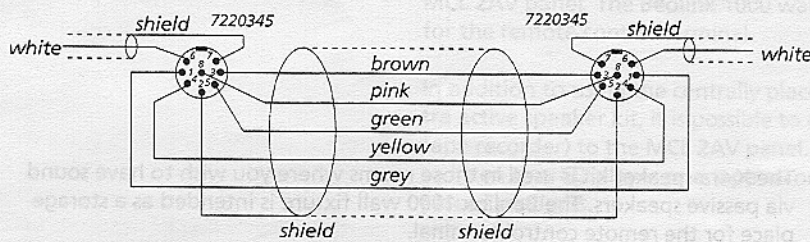

③ 8-pin DIN cable, Power Link cable, for connection of the Master and MCL 2P or Beolab amplifier:

- green = signal, right channel
- brown = signal, left channel
- grey = power up/down
- pink = overload
- yellow = loudspeaker relay
- shield = ground
- white = Datalink



## PRODUCT DESCRIPTION

Below you will find a description of the individual elements included in the Local Control System as well as their scope of application.

### Content

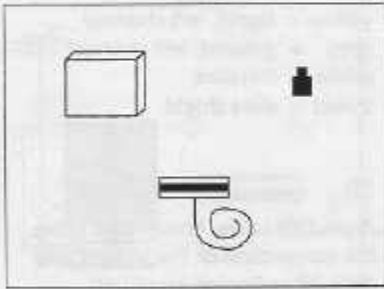

### X-TRA SPEAKER KIT

The X-tra speaker kit contains an MCL 2A relay box, a transceiver, a Beolink 1000 wall fixture and fittings for installation.

### Application

The X-tra speaker kit is used in those rooms where you wish to have sound via passive speakers. The Beolink 1000 wall fixture is intended as a storage place for the remote control terminal.

### Miscellaneous

In addition to the content of the X-tra kit and the passive speakers, some MCL cable and perhaps some plugs and connection boxes are required. (See the section on installation for further information, if required.)

When using the X-tra speaker kit the volume adjustment is common with that in the Central room and any other X-tra speaker kits.

**Content**

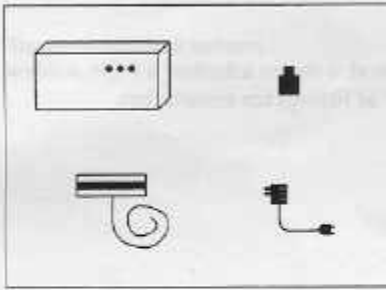

**X-TRA ACTIVE SPEAKER KIT**

The X-tra active speaker kit contains an MCL 2AV panel, a transceiver, a mains adaptor, a Beolink 1000 wall fixture as well as fittings for installation.

**Application**

The X-tra active speaker kit is used in those rooms where you wish to have sound through active speakers. The mains adaptor supplies power to the MCL 2AV panel. The Beolink 1000 wall fixture is intended as a storage place for the remote control terminal.

In addition to using the centrally placed audio and video systems via the X-tra active speaker kit, it is possible to connect local sources (CD player and tape recorder) to the MCL 2AV panel. Connection of local sources allows you to listen to a CD player or a tape recorder independently of the centrally placed products.

The X-tra active speaker kit has built-in "volume control". This volume control permits you to reduce the volume in the Local room without affecting the volume in other rooms. The volume can be increased by 12 dB in the Local room without affecting the volume in other rooms. If the volume is increased further, the volume in other rooms will be increased comparatively.

**Miscellaneous**

In addition to the content of the X-tra kit and the active speakers, some MCL cable and perhaps some plugs and connection boxes are required. (See the section on installation for further information, if required.)

**REMEMBER**

When planning an installation, remember that both the active speakers and the MCL 2AV panel have to be connected to the mains.

## Content

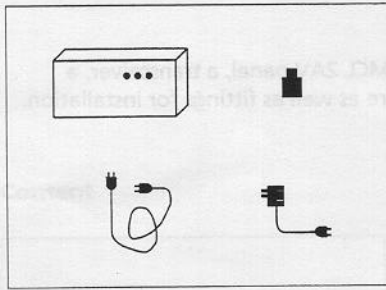

### X-TRA TV KIT

The X-tra TV kit contains an MCL 2AV panel, a mains adaptor, a 7-pin Auxlink cable, a Beolink 1000 wall fixture as well as fittings for installation.

## Application

The X-tra TV kit is used in those rooms where you wish to have sound and picture via a Bang & Olufsen TV set\*. The 7-pin Auxlink cable forms the connection between the MCL 2AV panel and the TV set. The mains adaptor supplies power to the MCL 2AV panel. The Beolink 1000 wall fixture is intended as a storage place for the remote control terminal.

In addition to using the centrally placed audio and video system via the X-tra TV kit, it is possible to connect local sources (CD player and tape recorder) to the MCL 2AV panel. Connection of local sources allows you to listen to a CD player or a tape recorder independently of the centrally placed products. In the local room with the X-tra TV kit, the volume can be adjusted without affecting the volume in other rooms.

If the centrally placed audio system is set to a very low-volume starting level, volume adjustment of the X-tra TV in the local room will have a slight effect on the volume in other rooms.

\* The X-tra TV kit is designed for use only with an MX5500 or an MX5000 equipped with TwoWay software (SW 2.2, part number 8341369).

## Miscellaneous

In addition to the content of the X-tra kit and the TV set, some MCL cable and perhaps some plugs and connection boxes are required. (See the section on installation for further information, if required).

### REMEMBER

When planning an installation, remember that both the TV set and the MCL 2AV panel have to be connected to the mains.

## SETUPS

### Recommended setups

An object consisting of several parts can usually only be assembled in one way if the intended result is to be achieved. For example, a gearbox for a car will not perform optimally according to the specifications if you omit installing some of the gearwheels. If you manage to instal one gearwheel too many, that will be most likely to cause trouble as well.

The point of the above is that things must be put together in the way they were designed to be put together if they are to perform optimally.

The same applies to Bang & Olufsen's AV and Local Control Systems. In theory, Bang & Olufsen's products may be connected in many thousands of different ways. Since it would be totally impossible to have an overview of just a fraction of this multitude of connection possibilities, Bang & Olufsen has selected the most attractive combinations. These selected combinations are called recommended setups. The recommended setups are the ones which are focused on in connection with product development and service.

When an AV system and/or a Local Control System is configured it is therefore very important that this is done in accordance with the recommended setups.

If the recommended setups are not followed, the result may easily be the same as with the gearbox with too many or too few gearwheels.

Bang & Olufsen services the recommended setups ONLY.

### Option programming

One of the conditions for the recommended setups to perform optimally is that the products included in the setup "know" in what kind of environment they are placed.

Are they standing alone (stand-alone products) or are they standing together with other products. When option programming the products, you "tell" them whether they are stand-alone products or they are standing together with other products. After the option programming, the products will perform optimally in the given setup.

The actual option programming is executed by pressing a certain sequence of keys on the Beolink terminal.

The entire B&O AV system MUST be in standby before option programming can be performed.

The key sequence is the following:

Beovision :	●	PICTURE	"digit"	STORE
Beomaster :	●	SOUND	"digit"	STORE
Local room products :	●	LINK	"digit"	STORE

Other products need not/cannot be option programmed.

The digit to be used depends on the setup.

See the illustrations below.

It applies to most setups that they are delivered in the correct option from the factory, and they are thus "ready for use".



However, since in some situations you may have to work with products that have been installed before, e.g. in connection with a house that has been rebuilt, the correct option is indicated at ALL illustrations, even those which are "ready for use" from the factory.

**NOTE!**  
If the option programming is not executed correctly, error functions will occur.

**Recommended AV systems**

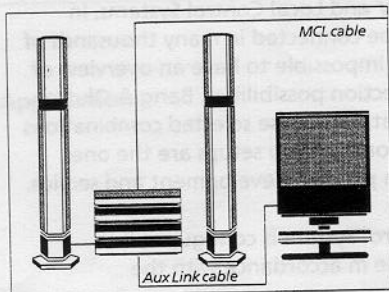

**AV system in one room**

Option programming : Option 1 (Factory setting)

Beovision :  PICTURE 1 STORE

Beomaster :  SOUND 1 STORE

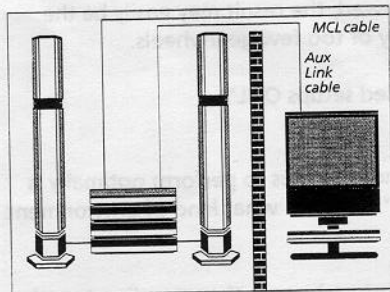

**AV system in two rooms**

Option programming : Option 2

Beovision :  PICTURE 2 STORE

Beomaster :  SOUND 2 STORE

**Recommended Local Room setups**

One or several recommended Local room setups may be connected to the above-mentioned Central room.

**NOTE!**  
If the audio system in the Central room is a BS 2500, see the section on special setups.

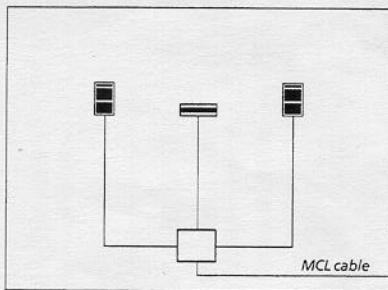

**Passive speakers in Local room**

Option programming : Option 2 (Factory setting)

MCL 2A :  LINK 2 STORE

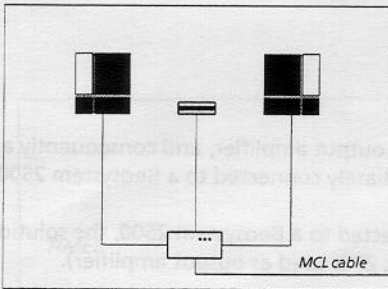

**Active speakers in Local room**

Option programming : Option 2 (Factory setting)

MCL 2AV :  LINK 2 STORE

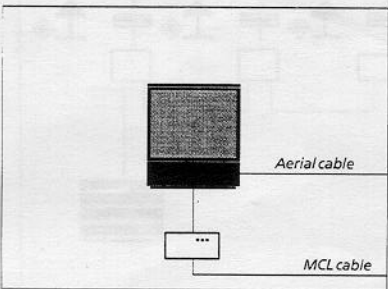

**TV in Local room**

Option programming : Option 2

Beovision :  PICTURE 2 STORE

To be able to receive video tape recorder from the Central room, the TV in the Local room has to be set (tuned in) to receiving the modulator frequency of the video tape recorder.

**X-tra active speaker kit with MCL 2P**

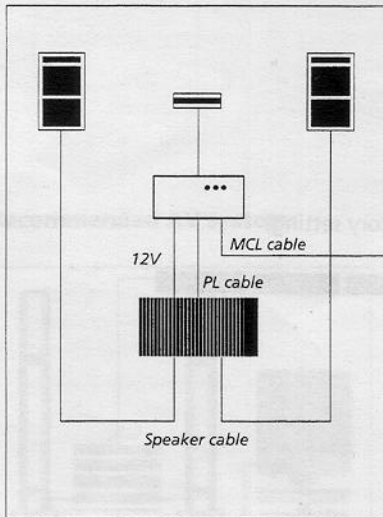

Option programming : Option 2 (Factory setting)

MCL 2AV :  LINK 2 STORE

Note:  
Passive speakers are connected to MCL 2AV via MCL 2P which is an output amplifier.

**Beosystem 2500 with MCL**

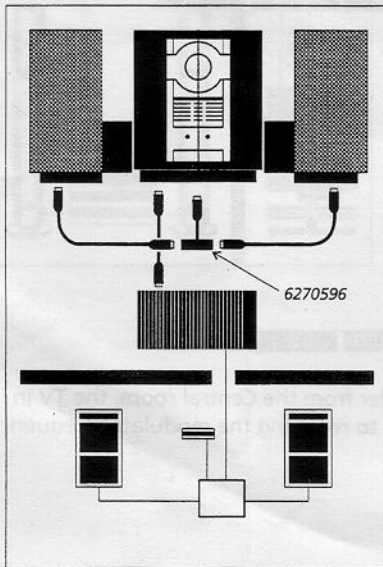

Beosystem 2500 do not have a built-in output amplifier, and consequently a Local Control System cannot be immediately connected to a Beosystem 2500.

If a Local Control System is to be connected to a Beosystem 2500, the solution shown below must be employed. (MCL 2P is used as output amplifier).

**SETUPS WITH LIGHT CONTROL**

The Local Control System allows operation and enjoyment of a centrally placed audio and video system from different rooms in the house.

Furthermore, the light in the entire house may be controlled via the Local Control System. You may sit in any room in the house and control the light in the rest of the house (link light control). This can be done either by means of the Beolink terminal or through timer programming.

Up to nine Light Controls can be connected in each room. A condition for achieving link light control is that the transceivers in the setups are set to transmitting link light commands. This setting is programmed in the following way:

First ensure that the entire system is in stand-by.

While pressing the "TIMER" key on the transceiver, enter a digit (1, 2, 3 or 4) into the Beolink terminal.

Each digit must not be repeated more than four times.

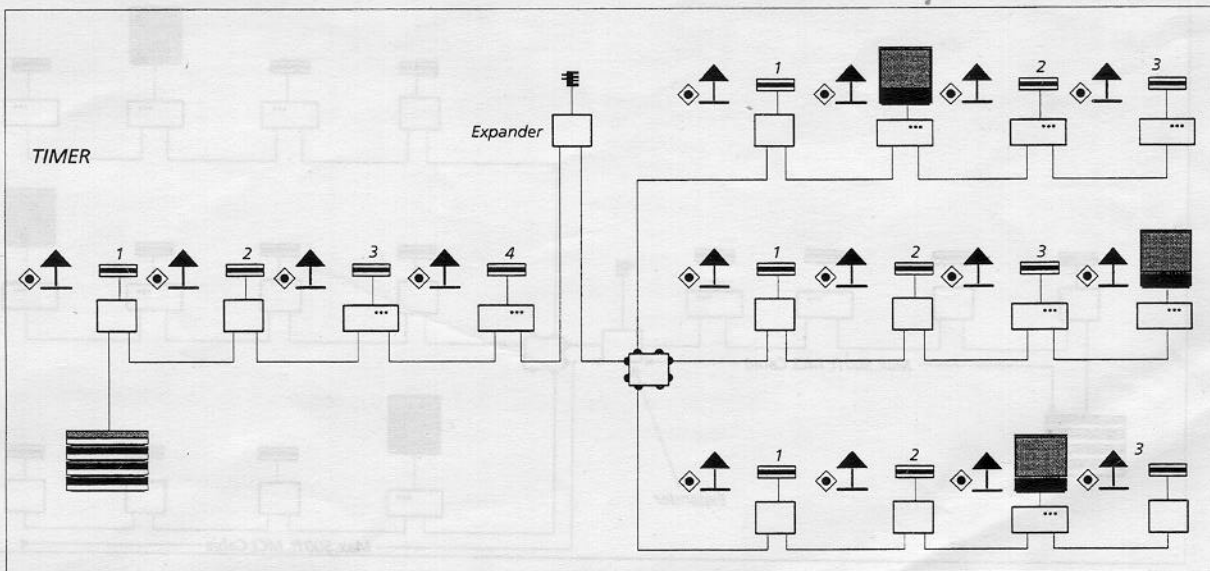

Link light control can also be transferred via Beovision. Beovision are set by the factory to transferring link light control, and no additional programming in connection with light control is therefore required.

Link light control is not possible with all audio systems (Beosystem 2500, Beocenter 8000/8500, Beosystem 3500, Beocenter 9000, Beosystem 5500)



## DIMENSIONING

It is possible to connect four MCL 2A's or 2AV's to a Beomaster or a Beocenter, and a maximum of 500 ft. of MCL cable may be used.

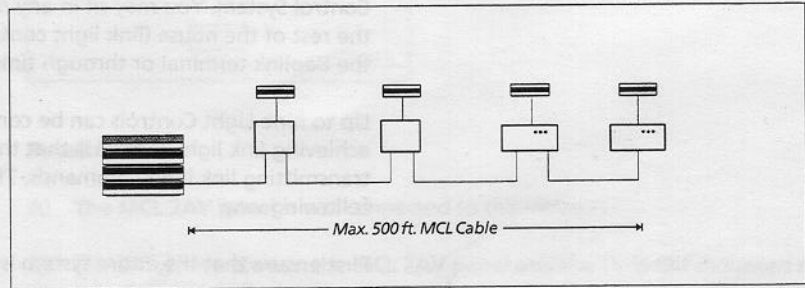

If the number of MCL 2 units is increased, or if more than 500 ft. of cable is used, it is necessary to insert an MCL 2 Expander.

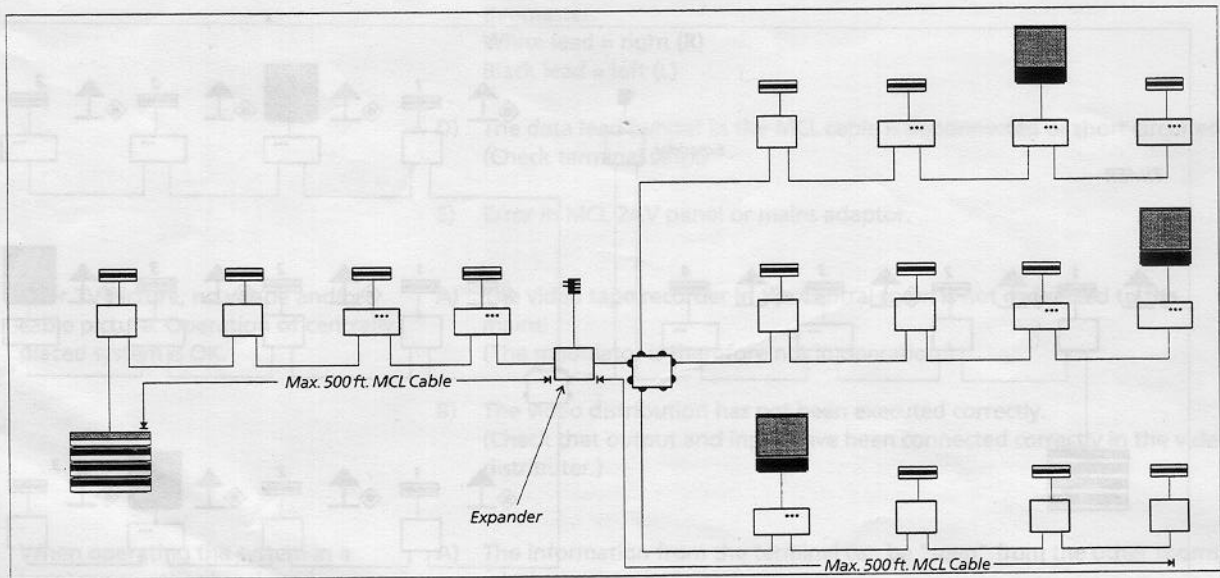

An additional 12 MCL 2 units can be connected to the MCL 2 Expander. These 12 units can be distributed in up to three strings with a maximum of four units in each string. The total cable length connected to the MCL 2 Expander must not exceed 1500 ft. (3 x 500 ft.). The MCL 2 Expander should be placed as close to the audio master as possible.

*Applicable to the MCL 2A only.*

As the speakers in the local rooms are connected in parallel, there is a limit to the number of local rooms in which the speakers can be cut in simultaneously. If too many speakers are cut in at the same time, the protection circuit of the audio master will be activated and either lower the volume or switch the whole system into stand-by.

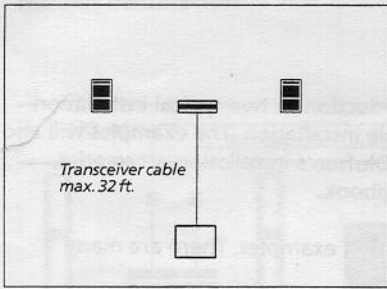

The cable between the transceiver and the relay box must not exceed 32 ft. 16 ft. is mounted ex factory.

If more than 32 ft. is used, there is a risk of malfunction.

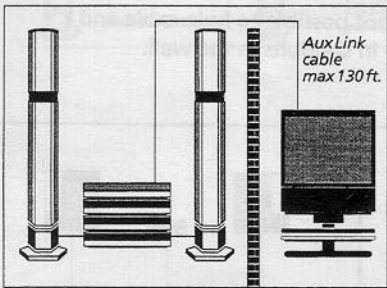

The 7-pin Auxlink cable which is used between the audio and video system or MCL 2AV and the TV should not exceed 80 ft. A longer cable will result in a poorer sound quality (example: 130 ft. = -3dB at 20kHz).

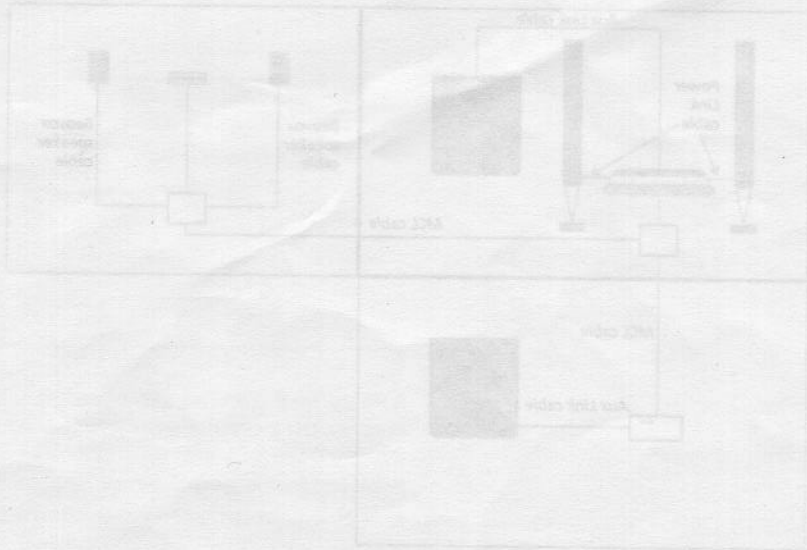

The illustration shows a typical installation, executed according to the star distribution principle.

In this example the following has been used:

- 1 x MCL cable with two plugs
- 1 x Connection box
- MCL cable by the manufacturer
- 1 x 7-pin Auxlink cable
- 1 x X-ra speaker kit
- 1 x X-ra TV kit

Furthermore, various speaker cabling is required, depending on the type of speaker.

## INSTALLATION TYPES

The following section gives a brief introduction to two typical installation types, namely the visible and the invisible installation. The examples will also include various applications of Bang & Olufsen's installation accessories, which are shown at the end of the handbook.

The illustrations give only a few installation examples. There are many alternatives, of course.

### Visible installation.

A visible installation is used where it is not possible to hide cable and installation materials in the attic and/or in conduits in the wall.

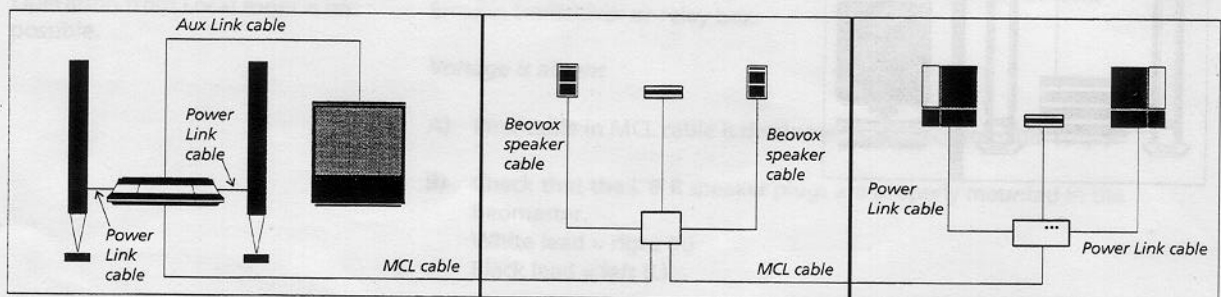

The illustration shows a visible installation, executed according to the loop-through principle.

In this example the following has been used:

- 1 x MCL cable with two plugs
- 1 x 7-pin Auxlink cable
- 1 x X-tra speaker kit
- MCL cable by the metre
- 1 x X-tra active speaker kit
- Furthermore, various speaker cabling is required, depending on the type of speaker.

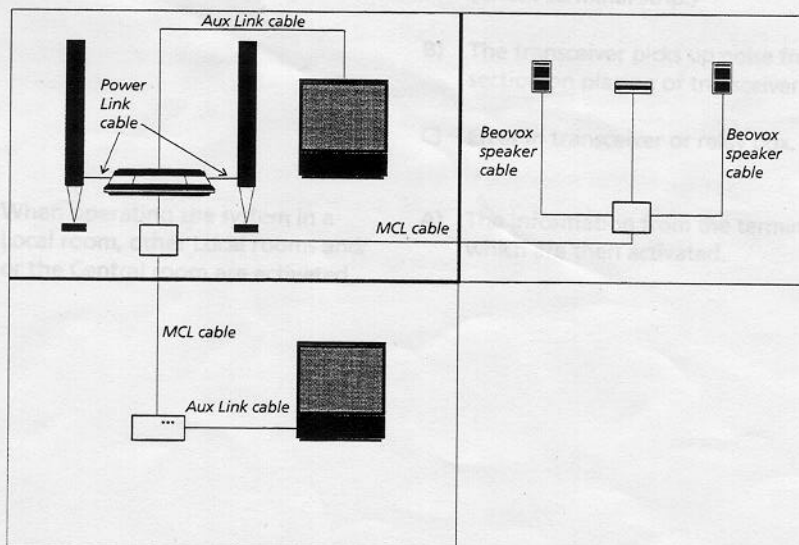

The illustration shows a visible installation, executed according to the star distribution principle.

In this example the following has been used:

- 1 x MCL cable with two plugs
- 1 x Connection box
- MCL cable by the metre
- 1 x 7-pin Auxlink cable
- 1 x X-tra speaker kit
- 1 x X-tra TV kit
- Furthermore, various speaker cabling is required, depending on the type of speaker.



**Hidden installation**

In this type of installation it is possible to hide the cables and installation materials in the walls and/or in the attic.

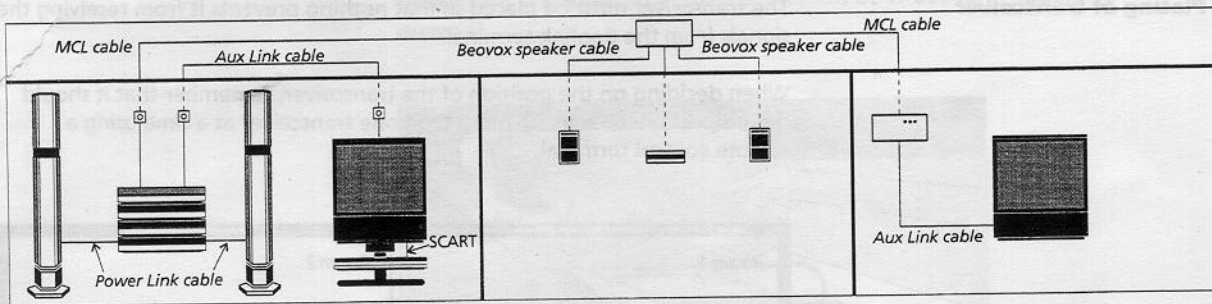

The illustration shows an invisible installation. In this example the following has been used:

- 1 x MCL cable with two plugs and 1 DIN plug
- 3 x 8-pin wall plates
- 3 x 7-pin Auxlink cable
- Auxlink (bulk)
- MCL cable (bulk)
- 1 x fixture box for transceiver
- X-tra speaker kit
- X-tra TV kit
- Furthermore, various speaker cabling is required, depending on the type of speaker.

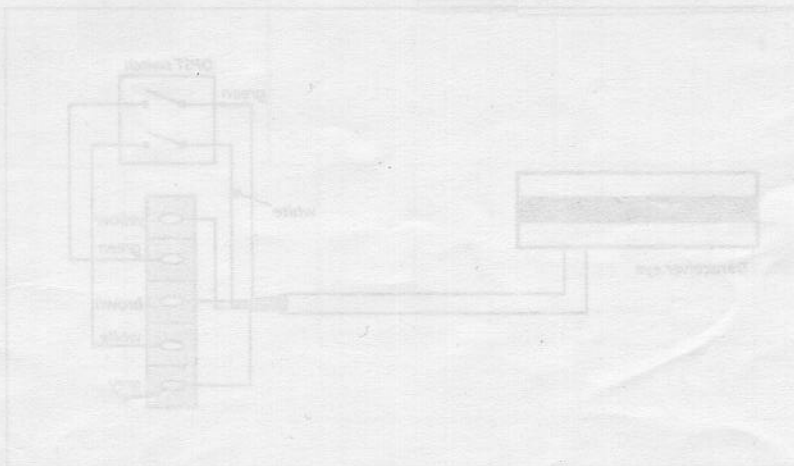



## INSTALLATION TIP

### Placing of transceiver

The transceiver must be placed so that nothing prevents it from receiving the signals from the Beolink terminal.

When deciding on the position of the transceiver, remember that it should not be possible to activate more than one transceiver at a time using a remote control terminal.

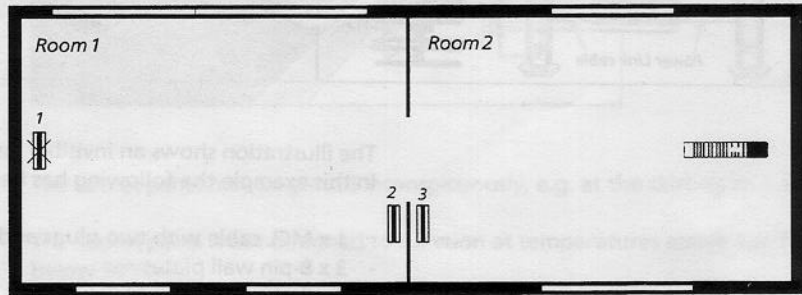

The diagram shows that transceiver 3 is placed appropriately, whereas transceiver 1 can be activated from room 2. Transceiver 1 should be placed as transceiver 2 instead.

The transceiver should not be placed in direct sunlight or direct artificial light (e.g. spotlight) or near objects producing electric noise (e.g. dimmers) as this reduces the sensitivity of the transceiver (shorter range).

If the transceiver is placed outdoors, please note that it does not function at temperatures above 131°F or below 32°F. If higher or lower temperatures may occur, it should be possible to switch it off by means of a switch. Otherwise, it can block the operation of the whole system. The transceiver must be mounted in an outdoor mounting box (see diagram).

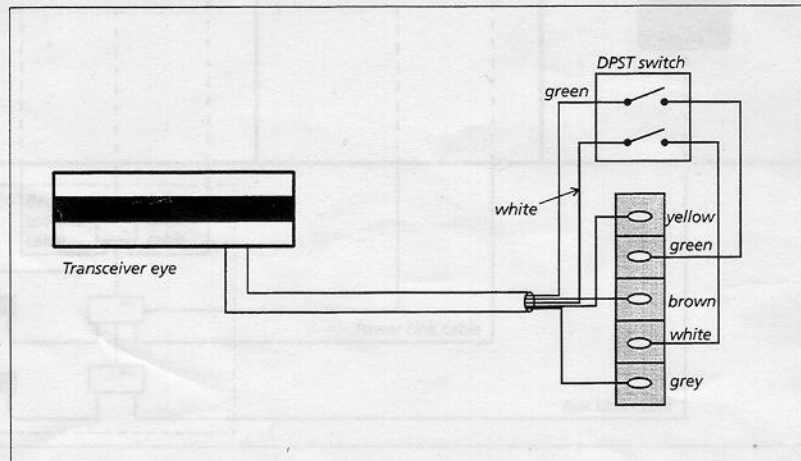

It might be a good idea to place the transceiver next to a door so that it is easy for the person entering or leaving the room to operate it.

It might also be an advantage to place the transceiver close to the telephone so that the speakers can easily be switched off by the person talking on the phone.

The relay box need not be placed in the same room as the transceiver but may be placed in the attic, for example.

**Placing of MCL 2A relay box**

Examples of placing:

The relay box is not designed to function at temperatures above 149°F or below 32°F. If it is placed in the attic, it must be wrapped in insulating material.

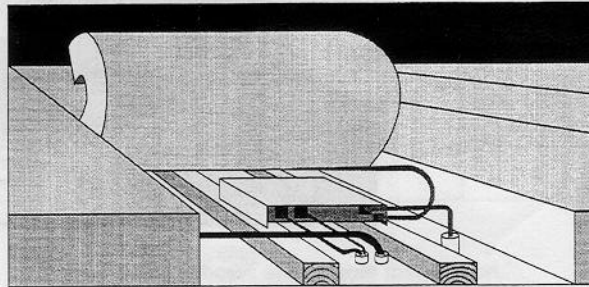

If it is not possible to place the relay box concealed in the attic or under the floor, it can be flush-mounted in the wall, using a flush-mount box.



### Placing of MCL 2AV panel

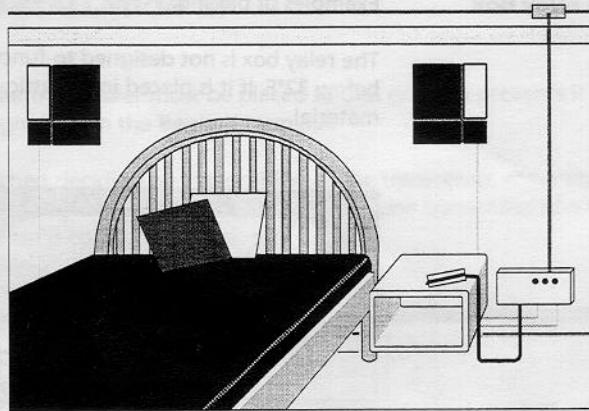

The socket panel may be placed inconspicuously, e.g. at the skirting of a wall.

The socket panel is not designed to function at temperatures above 104°F or below 50°F.

Due to the cable length, it must be placed within reach of an AC outlet and local sources, if any.\*

\* This applies to active speakers, too.

### Central placing of relay boxes and MCL 2AV panel

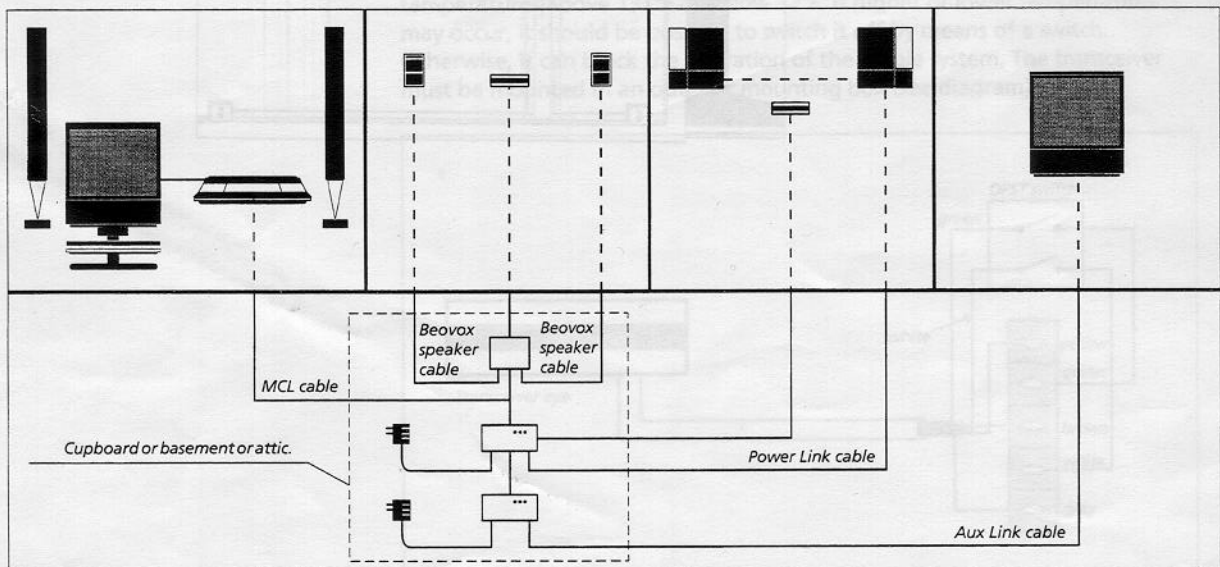

As appears from the illustration, relay boxes and panels can be placed in a central location. (However, maximum cable lengths must not be exceeded, and the same applies to maximum and minimum ambient temperatures. See the section on dimensioning for further information, if required).

Possible advantages of a central placing could be that the LCS units are easier to hide, MCL 2AV panels could use a joint current output, etc.



**TROUBLE SHOOTING GUIDE****IMPORTANT!**

Before troubleshooting the MCL system, verify that the following set-up guidelines have not been exceeded.

1. Up to four links and 500 ft. of MCL cable may be used without additional accessories.
2. If more than 4 links or more than 500 ft. of cable are used, an MCL 2E expander must be installed. (See section on Dimensioning).
3. Make sure the transceivers are installed in such a way that the remote terminal can only "see" one transceiver at a time.
4. Verify on transceivers with additional cable that the length of the cable does not exceed a total of 32 ft.
5. Transceivers should not be placed near the sources of strong radio frequency or infrared interference (light dimmers, infrared alarms, direct sunlight, etc.).
6. Transceivers installed outdoors must be mounted in a moisture resistant box (7210611 or equivalent). If outdoor temperature falls below 32 degrees, a transceiver cutout switch should be installed. (See section on Installation Tip).
7. MCL relay boxes should not be installed in areas where the ambient temperature goes below 32 degrees or above 150 degrees Fahrenheit.

**NOTE:**

All references to MCL 2A also apply to X-tra speaker kits, and all references to MCL 2AV also apply to X-tra active speaker kits.

**Precautions to observe during trouble shooting.**

1. During the troubleshooting, it may be necessary to temporarily disconnect wires to take voltage measurements while the power to the main room system is still connected. Remember that simply reconnecting the wires afterwards may result in a data "lockup" rendering the system inoperable in the local rooms. Before going on, try resetting the system by disconnecting the AC mains from the main room components and all AC powered MCL components (MCL 2AV, MCL 2P, MCL 2E). Then reconnect the AC, first to the MCL components, and finally to the main room system.
2. The display on the Beolab® Penta/Panel speakers may not function after troubleshooting the system. Before proceeding further; disconnect the Beolab speakers from the AC mains, while the main room audio system is in STANDBY mode. Then reconnect the Beolab speaker.
3. Never cut MCL or transceiver cables unless the entire MCL system is powered down. This includes all AC powered MCL components and the main room audio system. Remember that power is supplied to the MCL system even when the main room system is in STANDBY mode.

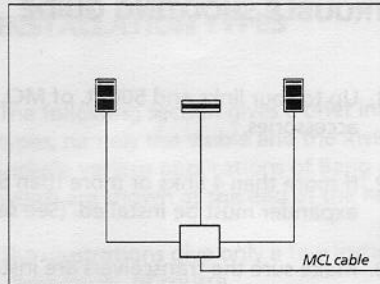

**X-tra speaker kit****Trouble**

The sound cannot be muted in the Local room.  
Operation from Local room is not possible.

**Possible cause**

Is supply voltage available at the terminal strip in the relay box?  
This can be checked by seeing if there is light in the timer button.  
Error in transceiver or relay box.

*Voltage is absent*

- A) Pink cable in MCL cable is disconnected. (Check terminal strip.)
- B) Check that the L & R speaker plugs are properly mounted in the Beomaster.  
White lead = right (R)  
Black lead = left (L)

*Voltage is too low (pink cable below approx 7.5 Volt or white cable below approx 4.5 Volt).*

- A) MCL cable too long.  
Too many Link units connected.
- B) Error in relay box or in transceiver (drawing too much current).

No sound in the Local room.  
Operation from the Local room not possible.

Does the speaker relay in the relay box click when the transceiver is used for operating?

- A) The data lead (white) in the MCL cable is disconnected or short circuited. (Check terminal strip.)
- B) The transceiver picks up noise from e.g. dimmer or light source. (See section on placing of transceiver.)
- C) Error in transceiver or relay box.

When operating the system in a Local room, other Local rooms and/ or the Central room are activated.

- A) The information from the terminal can be "seen" from the other rooms, which are then activated.

**X-tra active speaker kit**

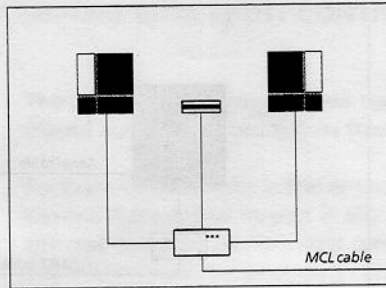

**Trouble**

Operation from the local room is possible, but no sound in the local room.

**Possible cause**

- A) The active speakers are not connected to the mains.
- B) The switches on the active speakers are not set properly.
- C) MCL cable is mounted incorrectly in the terminal strip on the MCL 2AV panel. (Check that green, yellow, grey & brown leads are correctly mounted in the terminal strip.)
- D) Power Link cable between speakers and MCL 2AV panel is disconnected.
- E) Check that the MCL 2AV is programmed in the proper option. (See the section on Option programming of AV systems).
- F) The MCL 2AV pre-programming has been changed. Pre-program the MCL 2AV to "active" mode. The main system and all MCL 2AV units is put in STANDBY mode, then hold down the TIMER button on the transceiver, press the AV button on a Beolink 1000 terminal.

No sound in the Local room. Operation from the Local room not possible.

- A) The MCL 2AV panel is not connected to the mains.
- B) MCL cable is not mounted or incorrectly mounted in the Beomaster.  
Check that the L & R speaker plugs are properly mounted in the Beomaster.  
White lead = right (R)  
Black lead = left (L)
- C) The data lead (white) in the MCL cable is disconnected or short circuited. (Check terminal strip.)
- D) The transceiver picks up noise from e.g. dimmer or light source. (See section on placing of transceiver.)
- E) Error in transceiver, MCL 2AV panel or mains adaptor.

Is the correct transceiver being used with the MCL 2AV?

Transceiver type 2045 cannot be used with MCL 2AV or X-tra active speaker kit.

When operating the system in a Local room, other Local rooms and/ or the Central room are activated.

- A) The information from the terminal can be "seen" from the other rooms, which are then activated.

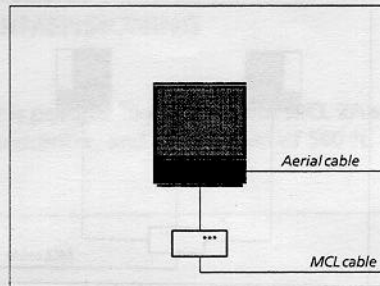
**X-tra TV kit****Trouble**

Use of the TV as an independent TV is OK but operation of the centrally placed system from the Local room is not possible.

**Possible cause**

- A) The MCL 2AV panel is not connected to the mains.
- B) The AV cable between the MCL 2AV panel and the TV is not mounted or it is disconnected.
- C) The MCL cable is not mounted or it is mounted incorrectly in the Beomaster.

Check that the L & R speaker plugs are properly mounted in the Beomaster.

White lead = right (R)

Black lead = left (L)

- D) The data lead (white) in the MCL cable is disconnected or short circuited. (Check terminal strip.)
- E) Error in MCL 2AV panel or mains adaptor.

Poor TV picture, no v.tape and/or cable picture. Operation of centrally placed system is OK.

- A) The video tape recorder in the Central room is not connected to the mains. (The modulator is therefore not in operation.)
- B) The video distribution has not been executed correctly. (Check that output and input have been connected correctly in the video distributor.)

When operating the system in a Local room, other Local rooms and/or the Central room are activated.

- A) The information from the terminal can be "seen" from the other rooms, which are then activated.



## GLOSSARY

### *MCL*

**Master Control Link** is the name/ designation of the connection/interface between the Central room and the Local room.

### *Central room*

Designation of the room in which the audio and/or video systems are placed. There are two kinds of Central room.

ONE-room Central room = Audio and video systems placed in the same room.

TWO-room Central room = Audio and video systems placed in separate rooms.

### *Local room*

Designation of the other room/rooms in the house in which sound and/or picture are installed.

### *Speaker link*

4-pin screened speaker cable.

### *Audio Aux link*

Perhaps better known as AV connection. Connection between the audio and video systems. Established through a 7-pin DIN cable.

### *Power Link*

8-pin DIN cable containing all necessary signals and data required for operating an active speaker (or an external output amplifier).

### *Audio master*

#### *audio product/system*

Designation of a Beolink-compatible Beomaster or Beocenter, e.g. Beomaster 7000, Beocenter 9500.

### *Video master*

#### *video product/system*

Designation of a Beolink-compatible Beovision TV set, e.g. Beovision MX5000, MX 5500.

### *Beolink-compatible*

Beolink-compatible products can be interconnected, thereby making them more functional.

### *Option programming*

Option programming is executed via a Beolink terminal and with the products concerned in stand-by.

Upon completed option programming, the products "know" what kind of environment they are placed in, and they can then be operated and function optimally.

### *21-pin AV cable/SCART*

Standard connection between a TV set and a video tape recorder. The cable is specified for transferring RGB signals.